



ISAF RACE MANAGEMENT MANUAL

2013

© ISAF (UK) Ltd. Douglas, Isle of Man Reproduction in whole or in part, without the written permission of the ISAF, is prohibited.

Edited by the ISAF Race Management Sub-Committee

© International Sailing Federation

First Edition 1994
Second Edition 1997
Third Edition 2002
Rewrite 2013.

Copies of this Race Management Manual and other ISAF publications can be obtained from:

ISAF UK Ltd.
Ariadne House
Town Quay
Southampton
SO14 2AQ
UK

Telephone: +44 23 80 635 111
Fax: +44 23 80 635 789
Email: secretariat@isaf.com
Website: sailing.org | isaf.com

PREFACE to 2013 Edition

This manual is designed to be a learning tool for Race Officers who are gathering knowledge and experience with the aim of becoming International Race Officers. It also should be a reference guide for existing Race Officers, with the aim of contributing to consistency in race management all over the world.

Since our sport is constantly changing and evolving, a manual such as this has to be a living document that needs to be updated constantly. It is a technical manual rather than a complete scenario for the official functions, ceremonies and social activities that come with yacht racing events. The responsibility for the contents of the Race Management Manual and keeping it up to date lies with the Race Management Sub Committee of ISAF.

It is by no means perfect, and contributions to improve it are always welcome and will be posted on the ISAF Web site as updates are made.

The origins of this manual can be traced back to the 1994 IYRU Race Management Manual prepared under the guidance of Karel H. Beukema toe Water. Chairman, Race Management Subcommittee (1991-1995).

In 1997 the RMSC prepared a update of the manual to include such items that are found at major events which includes a wide range of people: competitors, sponsors, the media, spectators, coaches, judges, organisers, and helpers. This was achieved under the Chairmanship of Bryan Willis (1997) and the experience of his team consisting of Hans Kurt Andersen, Michel Barbier, Elias Caronis, Charley Cook, Tony Lockett, Jim Park, & Jost Wahlen.

In 2002, under the Chairmanship of Michel Barbier the manual was reviewed with simplification in mind. An important example of simplification was the introduction of Standardised Sailing Instructions, which we strongly recommend.

Absolute uniformity is not our dream but just think about the benefit of consistency and simplification for interclub and international competitors ... It's sometimes important to change his our way of doing things to be consistent with accepted practices, even if your club has always acted in a different way. Flexibility is a key function of race committees by paying attention to particular needs of competitors, judges, measurers and organisers at each event.

Thanks to the Race Management Sub-committee members: Helmut Jakobowitz, Antony Lockett, Guisepppe Masini, Miklos Nemeth, Luis Ormaechea, Mark Pryke, Robin Wallace, Nino Shmueli, and Bill Bell for updating this manual.

A special thought for Elias Caronis, who always knew how to envisage the future of our sport.

I take this opportunity to thank the many experienced International Race officers, past and present, and the current RMSC members: Tomasz Chamera, John Parrish, Nino Shmueli, Christophe Gaumont, Ion Echave, Ricardo Navarro, Thomas Jorgensen, Hans-Peter Hylander, Rafael Gonzalez, Adrian Stoggall, Eckart Reinke, Ilker Bayindir, Robin Wallace, Helmut Jakobowitz, Antanasios papantoniou, Qu Chun who contributed to this manual. A special mention to Rob Lamb, Gerard Bosse (Match Racing Committee) and Sandra Robinson for their contributions and to Marina Psychogiou for all her work in editing this new manual and keeping some consistency across the document.

Ross Wilson
Chairman, ISAF International Race Management Sub-Committee (2009- 2012)

ISAF RACE OFFICIALS MANUALS COMMON SECTIONS

Section 1 – The Court of Arbitration for Sport (CAS)

1.1	Introduction	1 / 2
1.2	Jurisdiction, Documents and Rules	1 / 2
1.3	CAS Hearings	1 / 2
1.4	ISAF Contact if involved in a CAS Hearing	1 / 3

Section 2 – Support Persons At Regattas

2.1	Introduction	2 / 2
2.2	Definition of Support Persons, Coaches, Team leaders, Parents and Others	2 / 2
2.2.1	Relationship with Support Persons	2 / 3
2.2.2	Professional Coaches	2 / 3
2.2.3	Parents as Supporters	2 / 4
2.2.4	Other Support Persons	2 / 4
2.3	Regatta Services to Competitors	2 / 4
2.4	Initial and Daily Briefings for Competitors and Support Persons	2 / 5
2.4.1	Other Communications During the Regatta	2 / 7
2.5	Support Boats on the Water	2 / 8
2.6	Establishing Exclusion Zones on the Water	2 / 8
2.6.1	Safety Plans Involving Support Boats Afloat	2 / 9
2.6.2	Communication with Support Persons on the Water	2 / 10
2.7	Judges' Debriefing on Rule 42 Penalties	2 / 10
2.7.1	Umpires Communications to Competitors	2 / 10
2.8	When Things Go Wrong	2 / 11
2.8.1	Procedures to Investigate and Penalise under the <i>Rules</i>	2 / 11
2.8.2	Incidents Involving Parents and Other Support Persons	2 / 12
2.9	Allegations of Physical or Sexual Abuse of a Youth by a Coach, Parent or Support Person	2 / 12

Section 3 - Crisis Management

3.1	Objectives	3 / 2
3.2	Introduction	3 / 2
3.3	Risk Assessment and Crisis Management Plan	3 / 2
3.3.1	Risk Assessment	3 / 2
3.3.2	Crisis Management Plan	3 / 2
3.4	Influence of Event Types on Safety Provision	3 / 3
3.5	Responsibilities	3 / 3
3.5.1	Competitors	3 / 3
3.5.2	Race Officer	3 / 3
3.6	Outline Structure of Safety Plan	3 / 4
3.6.1	Dinghy and Board Events	3 / 4
3.6.2	Ocean, Offshore and Yacht Racing Events	3 / 8

Section 4 - Race Officials and Junior Sailors

4.1	Introduction	4 / 2
4.2	Definition of Junior Sailors	4 / 2
4.3	Race Officials Role at Junior Regattas	4 / 3
4.4	Visibility	4 / 3
4.5	Communication With Sailors and Their Coaches	4 / 4
4.6	Protests	4 / 4

4.7	Observers	4 /4
4.8	Use of the Protest Flag	4 /5
4.9	Reporting to the Race Committee At The Finish	4 /5
4.10	Arbitration	4 /5
4.11	Rule 42 and Appendix P	4 /5
4.12	Regatta Briefings	4 /6
4.13	Parents, Coaches and Club Support	4 /7
4.14	Support Boats	4 /7
4.15	Rule 69 Gross Misconduct	4 /7
4.16	Sailor's Ethics	4 /8
4.17	Legal Obligations of Child Protection	4 /8
4.18	Outside Assistance	4 /9
4.19	ISAF Introductory Rules of Racing	4 /9
4.20	Sailing Instructions	4 /9

Section 5 – Handling Misconduct

5.1	Introduction	5 /2
5.2	When should rule 69 be used	5 /2
5.3	Who is subject to rule 69.1	5 /2
5.4	Types of behaviour justifying a rule 69 hearing	5 /3
5.5	Who may make a report	5 /3
5.6	Form of Report	5 /3
5.7	Who should the report be lodged to	5 /3
5.8	Reports lodged with organizing authorities/clubs/other authorities	5 /4

Appendix A – Examples of Gross Misconduct	5 /5
---	------

Section 6 – Guidelines for Dealing with the Media

6.1	Introduction	6 /2
6.2	Definition	6 /2
6.3	ISAF's approach to the media	6 /2
6.4	What to do and what not to do when talking to the media	6 /2
6.4.1	Do	6 /3
6.4.2	Do not	6 /4
6.4.3	Understanding how journalists work	6 /4
6.4.4	Keeping a record of press contacts	6 /5

ISAF RACE MANAGEMENT MANUAL SECTIONS

A The Basics

A 1	Introduction	A 2
A 2	Terms	A 2

B ISAF International Race Management Programme

B 1	How to Become an International Race Officer	B 2
B 2	Terms of Appointment	B 3
B 3	Application for Appointment and Re-Appointment	B 4
B 4	General Qualifications required of all International Race Officials and Additional Qualifications for all International Race Officers.	B 4
B 5	Considerations for Appointment	B 5

C Qualities Of An International Race Officer

C 1	Code of Behaviour	C 2
-----	-------------------	-----

D	Reserved for future use	
E	Authority and Responsibility	
E.1	Authority and Responsibility	E 1
F	Committees and Key Personnel	
F 1	Guideline plan for a major event organization	F 3
F 2	Regatta Organizing Committee	F 4
F 3	Race Office Organization	F 5
F 3.1	Entries and Registration	F 7
F 3.2	Reception and General Information	F 8
F 3.3	Results and Competition Information	F 9
F 3.4	Printing and photocopy support	F 10
F 3.5	Meteorology & weather reports	F 11
F 3.6	Race Office – Major Events	F 11
F 4	The Race Committee	F 13
F 4.1	ISAF or Class Race Officer	F 13
F 4.2	Principal Race Officer	F 13
F 4.3	Race Officer	F 14
F 4.4	Deputy Race Officer.	F 14
F 4.5	Assistant Race Officer.	F 14
F 4.6	Visual Signals Officer	F 14
F 4.7	Gunner/Sounder	F 14
F 4.8	Timekeeper	F 15
F 4.9	Recorder	F 15
F 4.10	Course-setter	F 16
F 4.11	Pin End Boat Crew	F 16
F 4.12	Beach Master	F 16
F 5	Judging - The Protest Committee	F 17
F 5.1	Protest Committee	F 17
F 5.2	Independent Protest Committee (Jury)	F 17
F 5.3	International Jury	F 17
F 5.4	Interaction of Protest Committee and Regatta Organizing Committee	F 18
F 5.5	Protest Committee duties	F 18
F 6	Umpiring	F 19
F 7	Measurement Committee	F 19
F 8	Safety Committee	F 20
F 8.1	Safety Officer	F 20
F 8.2	Personnel and equipment	F 20
F 8.3	Safety Operations Plan	F 20
F 9	Race Committee Vessels	F 21
F 10	Social Committee	F 21
F 10.1	Social activities	F 21
F 10.2	Opening ceremony	F 21
F 10.3	Closing ceremony	F 22
F 11	Press & Publicity Committee	F 22
F 11.1	General	F 22
F 11.2	Relationship with media	F 23
F 11.3	Press Office and facilities	F 23
F 11.4	Press and TV boats.	F 23
F 11.5	Press accreditation	F 23
F 12	Sponsorship Committee	F 24
F 12.1	General	F 24

F 12.2	Amount of sponsorship	F 24
F 12.3	Attracting sponsors	F 25
F 12.3	What can you offer the sponsor?	F 25
F 12.5	Contracts	F 25
G	Facilities and Infrastructure	
G 1	Race Office requirements	G 2
G 1.1	Signal mast	G 2
G 1.2	Official Notice Board	G 2
G 1.3	Public address system	G 3
G 2	Boat facilities	G 3
G 2.1	Infrastructure	G 3
G 2.2	Moorings	G 4
G 2.3	Team containers	G 4
G 2.4	Changing rooms	G 4
G 2.5	Meeting rooms	G 4
G 2.6	Communication Centre	G 5
G 2.7	Press and Media Centre	G 5
G 2.8	Drug Testing	G 5
G 3	On shore facilities	G 5
G 3.1	Boat washing	G 5
G 3.2	Parking	G 5
G 3.3	Fuel supply	G 5
G 3.4	Boat spares	G 6
G 4	Press, Media, Sponsors, VIP's	G 6
G 4.1	Press	G 6
G 4.2	Media	G 6
G 4.3	Sponsors and VIPs	G 6
G 4.4	Communications	G 7
G 5	Off-site facilities	G 7
G 5.1	Repair facilities	G 7
G 5.2	Medical facilities	G 7
G 6	Transportation and Security	G 7
G 6.1	Transportation	G 7
G 6.2	Security	G 7
H	Vessels and Equipment	
H 1	Main Race Committee boat	H 2
H 2	Mark Laying Boat	H 2
H 3	Mark boats	H 3
H 4	Pin End Start Boats	H 3
H 5	Patrol/Safety boats	H 3
H 6	Signal boat	H 3
H 7	Jury and Umpire boat(s)	H 4
H 8	Marks	H 4
H 8.1	Start Line Mark	H 5
H 8.2	Finish Line Mark	H 5
H 8.3	Other Marks	H 5
I	Race Documents	
I 1	The Notice of Race	I 2
I 2	The Sailing Instructions	I 2
I 3	ISAF Regulations	I 3

I 4	National authority prescriptions	I 4
I 5	Class Rules	I 4
I 6	Any other documents that govern the event	I 4
J	Competition Formats, Course and Race Areas Selection	
J 1	Competition formats	J 2
J 1.1	Match Racing	J 2
J 1.2	Team Racing	J 2
J 1.3	Fleet racing	J 2
J 2	Course Selection	J 4
J 2.1	Course geometry	J 4
J 2.2	Tips to select the Course	J 5
J 2.3	Gates	J 5
J 2.4	Off-set mark	J 6
J 3	Course types	J 6
J 3.1	Triangle and Windward-Leeward Course	J 6
J 3.2	Windward-Leeward Course	J 7
J 3.3	Trapezoid Course – Inner and Outer loops	J 8
J 3.4	The offset mark	J 9
J 3.5	The Slalom	J 9
J 4	Describing the course in the sailing instructions	J 10
J 5	Selection of the race area(s)	J 10
K	The Start Of The Regatta	
K 1	Registration	K 2
K 2	Measurement and inspection	K 2
K 3	Team Leaders, coaches and competitors meetings	K 3
K 4	Race Officials meeting	K 4
L	Setting The Course	
L 1	Locating the Race Area	L 2
L 2	Position of the Race Committee Signal Boat and the leeward Mark	L 2
L 3	The starting line	L 3
L 3.1	Length and direction	L 3
L 3.2	Line bias	L 4
L 3.3	Inner Limit Mark	L 5
L 3.4	Correcting the line	L 5
L 3.5	The Pin End	L 5
L 3.6	Line boat action	L 5
L 4	The windward leg	L 6
L 5	Laying the other marks of the course	L 7
L 5.1	The Triangle-Windward/Leeward Course	L 8
L 5.2	The Olympic Trapezoids (Inner and Outer Loop)	L 10
L 5.3	The Windward/Leeward course	L 12
L 5.4	The Slalom Finish course	L 13
L 6	Adjusting a Course for Wind Changes	L 13
L 6.1	Race Committee action	L 14
L 6.2	Windward leg	L 14
L 6.3	Leeward leg	L 14
L 6.4	Adjustment procedure	L 15
L 6.5	Trapezoid courses; shortening and lengthening of legs	L 16
L 7	Adjusting a course for currents	L 17
L 7.1	General effects of a current	L 17

L 7.2	Effect on the starting line	L 18
L 7.3	Effect on the windward leg	L 18
L 7.4	Effect on downwind legs	L 19
L 7.5	General	L 19
M	Starting Procedures	
M 1	Starting systems	M 2
M 1.1	RRS26 Starting System	M 2
M 2	The starting procedure	M 3
M 2.1	Guide of actions during the starting procedure	M 3
M 2.2	Sighting the line.	M 7
M 2.4	Communication with the pin end	M 8
M 3	Starting problems and solutions	M 8
M 3.1	Starting line	M 8
M 3.2	Line identification	M 8
M 3.3	Floating lines	M 9
M 3.4	Line adjustment	M 9
M 3.5	Delays	M 9
M 3.6	Boats on the course side of the starting line	M 9
M 3.7	Miscellaneous problems	M 11
M 4	The Gate Start	M 11
M 4.1	General	M 11
M 4.2	Procedure	M 11
M 4.3	Operation	M 12
M 4.4	Natural conditions required	M 13
M 4.5	Equipment	M 13
M 4.6	Other considerations	M 13
N	During The Race	
N 1	Fleet surveillance	N 2
N 2	Course changes	N 2
O	The Finish	
O 1	Types of finishing line	O 2
O 2	Laying the finishing line	O 3
O 3	Preparatory tasks	O 4
O 4	Finishing procedure	O 4
P	Things To Do At The End Of Each Racing Day	
P 1	Race Committee tasks before coming ashore	P 2
P 1.1	Accounting for all starters	P 2
P 1.2	Firearm safety	P 2
P 1.3	Advising essential particulars	P 2
P 1.4	Advising full results	P 2
P 1.5	Lifting marks	P 3
P 1.6	Dismissing auxiliary vessels	P 3
P 1.7	Advising auxiliary services	P 3
P 2	Race Committee tasks after coming ashore	P 3
P 2.1	Firearm safety	P 3
P 2.2	Special notices	P 3
P 2.3	Official results	P 3
P 2.4	Collecting race records	P 4
P 2.5	Initiating protest sequence	P 4

P 2.6	Protests from the Race Committee	P 4
P 3	Evaluation of performance	P 4
Q	Things To Do At The End Of The Regatta	
Q 1	The final results	Q 2
Q 2	Prize-giving ceremony	Q 2
R	Post-Regatta Tasks	
R 1	Logistics	R 2
R 1.1	Transport	R 2
R 1.2	Removal of signs	R 2
R 1.3	Return of equipment	R 2
R 2	Administration	R 2
R 2.1	Formal report	R 2
R 2.2	Letters of thanks	R 2
R 2.3	Finance	R 2
R 2.4	Final evaluation	R 3
S	Race Management Policies For The Olympic Sailing Competition and ISAF Events	
T	Race Management Of Match Racing	
T 1	Terms	T 2
T 2	Governing Documents	T 2
T 3	Organization	T 2
T 4	Competition Format	T 2
T 4.1	A choice	T 2
T 4.2	Round Robins	T 3
T 4.3	Recommended criteria for Round Robin pairing lists	T 3
T 4.4	Groups (or 'half round robins')	T 4
T 4.5	Knock-out competitions	T 4
T 4.6	Repechage	T 5
T 4.7	Tie break sail off	T 6
T 5	The Course	T 7
T 5.1	Location	T 7
T 5.2	Configuration	T 7
T 5.3	Duration	T 8
T 6	Meteorology	T 8
T 7	Equipment Failure	T 9
T 8	The start	T 11
T 8.1	The line	T 11
T 8.2	Starting Procedure	T 11
T 8.3	Requirements before the start: Rule C4.1	T 13
T 8.4	Requirements before the start: Rule C4.2	T 14
T 8.5	Individual Recalls: Rule C 3.2(a)	T 14
T 9	Postponement	T 17
T 9.1	Postponement before the starting sequence	T 17
T 9.2	Postponement during the starting sequence	T 17
T 10	Changing the next leg of the course	T 17
T 11	Shortening the Course	T 18
T 12	Abandonment	T 18
T 13	Relationships with Umpires	T 19
T 14	Match racing penalty system	T 20
T 15	Sighting the Finishing line	T 20

T 16	Scoring	T 22
T 17	Race Committee organization	T 22
T 17.1	Race Committee boat	T 22
T 17.2	Line sighting	T 24
T 17.3	Race Committee boat	T 24
T 17.4	Communications	T 24
T 17.5	The Windward Mark Layer	T 25
T 17.6	The Leeward Mark Layer	T 25
T 17.7	The Boat Master – Technical Team	T 25
T 17.8	The Crew Change Team	T 26
T 17.9	Consistency	T 26
T 18	Example of timetable	T 27
U	Race Management Of Team Racing	
U 1	Introduction	U 2
U 1.1	Document Overview	U 2
U 1.2	An Overview of Team Racing	U 2
U 1.3	Top things to get right for a successful regatta	U 2
U 1.4	Terms	U 3
U 2	Authority and Responsibility	U 3
U 3	Committees and Key Personnel	U 3
U 3.1	Race Office	U 3
U 3.2	Race Committee	U 4
U 3.3	Protests	U 5
U 3.4	Umpires and Judges	U 5
U 4	Facilities	U 6
U 4.1	Boats	U 6
U 4.2	Further Shore Facilities	U 7
U 4.3	Repair facilities	U 8
U 5	Vessels and Equipment	U 8
U 5.1	Course setting boat	U 8
U 5.2	Umpires	U 8
U 5.3	Marks	U 9
U 6	Race Documents	U 9
U 7	Competition Formats and Selection of Race Area	U 9
U 7.1	Formats	U 9
U 7.2	Selection of Race Area	U 10
U 8	Start of the Regatta	U 11
U 8.1	Competitor registration including damage deposit	U 11
U 8.2	Umpire meetings	U 11
U 9	Setting the Course	U 11
U 9.1	Course geometry	U 11
U 9.2	Location of Race Area	U 12
U 9.3	Length of starting line	U 12
U 9.4	Course	U 13
U 9.5	Adjusting a course for wind changes	U 13
U 10	Starting Procedures	U 13
U 10.1	Starting problems and solutions	U 14
U 11	During the Race	U 15
U 11.1	Fleet surveillance	U 15
U 11.2	Course changes	U 15
U 12	Finishing	U 16
U 13	Things to do at the End of Each Racing Day	U 16

U 14	Things to do at the End of the Regatta	U 16
U 15	Post Regatta Tasks	U 16
U 16	Annex 2.6	U 16
U 17	Annex 6.1	U 17
U 18	Annex 6.1.1	U 21
V	Safety Management	
V 1	Objectives	V 2
V 2	Introduction	V 2
V 3	Risk Assessment And Crisis Management Plan	V 2
V 3.1	Risk Assessment	V 2
V 3.2	Crisis Management Plan	V 2
V 4	Influence Of Event Types On Safety Provision	V 3
V 5	Responsibilities	V 3
V 5.1	Competitors	V 3
V 5.2	Race Officer	V 3
V 6	Outline Structure Of Safety Plan	V 4
V 6.1	Dinghy and board events	V 4
V 6.2	Ocean, offshore and yacht racing events	V 7
W	KITEBOARDING	
W 1	Objectives	W 2



ISAF RACE MANAGEMENT MANUAL

SECTION A

The Basics

Contents

Page

A	The Basics	
A 1	Introduction	A 2
A 2	Terms	A 2

A.1 Introduction

The role of the race officer is an on the water manager, who lets his team get on with the job without interfering, so that he should take the decisions regarding boats on the course side of their starting line, course changes, etc., himself. The advantage is that he can at all times keep an overview of what goes on around the entire race course.

Another important role is to make decisions to ensure the fairness of the competition. These may entail changes of course, abandoning the race or AP the sequence of racing if the wind is too light or shifting or too strong. It is not always easy to make these decisions and it is always a challenge for the race officer with these decision making procedures.

Sailboat racing owes a debt of gratitude to those people willing to accept this responsibility and to work to acquire the necessary knowledge and experience to do it well. Those who make such a commitment make a very large contribution to our sport

A.2 Terms

Race Officer, Principal Race Officer, National Race Officer, International Race Officer.

The race officer is the person in charge of running the sailing race. A principal race officer is a person who is in charge of two or more courses at a regatta. The title “national race officer” is given to a suitably qualified persons by a national authority. The title of “International Race Officer” is awarded by ISAF to a person who meets the criteria set out in the ISAF regulations

Racing Rules of Sailing (the “rules”)

The rules used by sailboats when racing under the jurisdiction of the International Sailing Federation.

ISAF Codes and Regulations

The ISAF Eligibility, Advertising and Anti-Doping Codes (ISAF Regulations 19, 20 and 21) are referred to in the definition of Rule. They are not included in the Racing Rules of Sailing because they often change during the four year publishing cycle of the rules. Changes are posted on the ISAF website at www.sailing.org and through member national authorities.

Case Book (the “cases”)

The ISAF publishes interpretations of the racing rules in The Case Book and recognizes them as authoritative interpretations and explanations of the rule. They are based upon appeals and questions submitted to the Racing Rules Committee. They clarify the meaning of a rule or answer questions about conflicting interpretations.

The rules, changes to the rules, and Cases are adopted by the ISAF Council, based upon recommendation of the Racing Rules Committee. This means that the Racing Rules of Sailing and ISAF Cases are authoritative. International Judges are required to follow ISAF rules and Cases when interpreting the rules.

International Sailing Federation (ISAF)

The international body governing the sport of sailboat racing is the International Sailing Federation. It comprises member national authorities, class associations, and other affiliated organisations. Among the many ISAF responsibilities and programmes is the training and certification of International Race Officials which include International Judges, Umpires, Race Officers, and Measurers.

National Authority

The national authority is the organization that governs the sport of sailboat racing within its jurisdiction, and is a member of ISAF, as well. Many national authorities have additional responsibilities, such as cruising and powerboat racing.

National authorities often prescribe additional rules to the racing rules. These prescriptions are included as rules governing sailboat racing within the jurisdiction of the national authority by the Sailing Instructions. They are rarely invoked for international events.

Most national authorities appoint a committee to hear appeals by boats against decisions of protest committees and by race committees against the decisions of protest committees. Appeal procedures vary from country to country through their prescriptions. The highest appeal authority is the national authority under whose jurisdiction the event is held. ISAF does not hear appeals.

National authorities may submit appeals that they think clarify or help interpret a rule to the ISAF Racing Rules Committee. If the committee agrees with the decision, or believes the clarification is beneficial it will accept the appeal as an ISAF case, subject to ratification by the ISAF Council.

Organizing Authority

The body that plans and runs the races or event is the organizing authority. It may be a club, a class association, a national authority, ISAF itself, or a combination of any of these. The organizing authority appoints the race committee. The organizing authority or the ISAF appoints the international jury and may appoint the protest committee.

Race Committee

The race committee is the committee appointed by the organizing authority to conduct the races. It is responsible for publishing the sailing instructions and for scoring. When the organizing authority has not appointed a protest committee or international jury, the race committee is responsible for appointing a protest committee to conduct hearings. Members of the race committee may sit on the protest committee, except for hearing a request for redress under rule 62.1(a). In that case, the protest committee must be independent of the race committee. A protest committee that is an international jury constituted in accordance with Appendix N of the rules shall be independent of and have no members from the race committee.

Protest Committee

The protest committee hears protests, requests for redress and alleged breaches of rule 69. It is appointed by the organizing authority or race committee. It may be independent of the race committee or a subcommittee of the race committee. It may, when meeting the requirements of Appendix N, qualify as an International Jury. From January 2009

International Juries are referred to as Protest Committees when hearing protests and requests for redress.

International Jury

An international jury is a protest committee that meets the requirements of Appendix N of the rules. It is appointed by the organizing authority and subject to approval by the national authority if required under their Prescriptions. It is independent from the race committee.

An international jury is composed of experienced sailors with excellent knowledge of the racing rules and extensive protest committee experience. Its membership is made up of people of different nationalities, the majority of whom shall be ISAF certified international judges. Provided that it conducts itself in accordance with the procedures described in Appendix N, as stated in Rule 70.5 its decisions shall not be subject to appeal.

Equipment Inspector, Measurement Committee, Measurement-related Authorities

The organizing authority of a major event may appoint –through the Race Committee – an equipment inspector (event measurer) or a measurement committee to inspect boats and check compliance to the measurement rules before the start of the competition, and carry out checks (such as sails set within limit marks, distribution of ballast, weight of clothing etc.) during the competition.

If during a hearing the protest committee is in doubt about the meaning of a measurement rule, it shall refer the question, together with the relevant facts, to an authority responsible for interpreting the rule, and is bound by the authority's decision. Class Rules Authority is the body that provides final approval of the class rules, their changes and class rule interpretations. Class rule interpretation procedures are defined in ISAF regulation 10.12, unless otherwise provided for in the ISAF-Class agreement defined in Regulation 10.3.

Judge, National Judge, International Judge

The term 'judge' is a term often used to describe a member of a protest committee who participates in decision making. The title 'national judge' is given to a suitably qualified person by a national authority that runs a 'national judges' scheme. The title of 'International Judge' is awarded by ISAF to a person who meets the criteria set out in the ISAF regulations.

Umpire, National Umpire, International Umpire

An umpire is a specially trained judge who makes decisions on the water, and may impose penalties, during a match or team race. Umpires may be called upon to hear protests during match racing and team racing events, as well.



ISAF RACE MANAGEMENT MANUAL

SECTION B

ISAF International Race Management Programme

Contents

Page

B	ISAF International Race Management Programme	
B 1	How to Become an International Race Officer	B 2
B 2	Terms of Appointment	B 3
B 3	Application for Appointment and Re-Appointment	B 4
B 4	General Qualifications required of all International Race Officials and Additional Qualifications for all International Race Officers.	B 4
B 5	Considerations for Appointment	B 5

B.1 How to Become an International Race Officer

ISAF created the International Accreditation Scheme for Race Officers to meet the needs of the competitors and to ensure that they had experience and consistency around the world for the management of sailboat racing.

Training and certification of sailboat racing officials and administrating the programme is one of the core purposes of the International Sailing Federation

The Race Management programme is administered under the authority of the Race Officials Committee through its sub committee, the International Race Management Sub Committee. Its responsibilities are stated in ISAF Regulations 6.9.10 and 31.

6.9.10 Race Management Sub-Committee

Constituting the committee

6.9.10.1 The Race Management Sub-committee (RMSC), which shall administer the International Race Officers programme, has been established by the Council as a Sub-committee of the Race Officials Committee pursuant to Article 42.

6.9.10.2 The Race Management Sub-committee shall consist of a Chairman and the number of members that shall be appointed by the Council from time to time as provided by Article 42.

Terms of reference

6.9.10.3 The Race Management Sub-committee shall:

- (a) administer the International Race Officers Programme;*
- (b) recommend to the Race Officials Committee the appointment of International Race Officers in accordance with these Regulations;*
- (c) disseminate information to and communicate with International Race Officers and Member National Authorities;*
- (d) be responsible for the instruction and evaluation of International Race Officers and candidates to become an International Race Officer, which shall include:
 - i) the development and conduct of seminars to train and qualify International Race Officers and candidates to become International Race Officers; and*
 - ii) the formulation of the examinations which applicants must pass to qualify as International Race Officers and, if required, the establishment of the criteria for a performance assessment and its administration;**
- (e) assist Member National Authorities in training and in developing national Race Officers programmes;*
- (f) recommend policies regarding the conduct of International Race Officers;*
- (g) administer programmes to promote uniform application and consistent interpretation of the Racing Rules and other ISAF documents by International Race Officers;*

- (h) *propose rule changes and submit interpretations of the Racing Rules to the Racing Rules Committee, the Race Officials Committee and other appropriate bodies;*
- (i) *recommend to the Racing Rules Committee standards for the Notice of Race Guide, and the Sailing Instructions Guide to achieve a high and uniform standard;*
- (j) *update International Race Officers Sub-committee documents, such as the Umpiring and Match Racing Manual, Performance Assessment forms and the International Race Officer application;*
- (k) *develop and administer a procedure for the grouping and classification of International Race Officers according to their abilities and to place them in groups based on agreed criteria;*
- (l) *work towards standardization and improvement of sailing instructions;*
- (m) *consider and propose race management policies for the Olympic Sailing Competition and ISAF Events;*
- (n) *address questions from International Race Officers;*
- (o) *deal with such matters as any ISAF Committee may request.*

Race Management Programme Administration: See Section VI, Regulation 31

B.2 Terms of Appointment

31 International Race Officials Administration – International Judges, Umpires, Measurers and Race Officers

- 31.1 *The provisions of this Regulation affect all International Race Officials, namely International Judges, International Umpires, International Measurers and International Race Officers, referred to collectively in this Regulation as ‘International Race Officials.’*
- 31.2 *The Race Officials Committee shall appoint International Race Officials after considering the recommendations of the Sub-committee that is responsible for the discipline concerned.*
- 31.3 *For the purposes of this Regulation references to ‘Principal Events’ shall mean those events described generally or designated as Principal Events by the Race Officials Committee and published on the ISAF Website. This Regulation shall not require the Secretary General to list each individual event.*

Term of Appointment

- 31.4 *The term of appointment for an International Race Official shall begin on the date it is made by the Race Officials Committee and,*
- (a) *if the applicant is less than seventy years old on the date of approval by the ROC, the duration of the appointment shall be four years.*
 - (b) *if the applicant is seventy years old or older on the date of approval by the ROC, the duration of the appointment shall be two years.*

In light of the decision by Council in November 2009 to modify the periods within which certain requirements must be met, the Race Officials Committee will adopt a transitional plan for applications for reappointment in 2010 through 2013 inclusive.

B.3 Applications for Appointment and Re-appointment

31.5 *A candidate for initial appointment shall:*

- (a) *be nominated by the candidate's Member National Authority, a Class/Owners Association or the Race Officials Committee;*
- (b) *be recommended by the candidate's Member National Authority;*
- (c) *send the application on the official form so that it is received by the Secretary General by 1 September; and*
- (d) *meet the general qualifications and the additional qualifications for the discipline concerned.*

31.6 *A candidate for re-appointment shall:*

- (a) *apply directly to ISAF;*
- (b) *send the application on the official form so that it is received by the Secretary General by 1 September; and*
- (c) *meet the general qualifications and the additional qualifications for the discipline concerned.*

31.7 *ISAF shall inform the candidate's Member National Authority of the application.*

31.8 *On applying for appointment or re-appointment, all International Race Officials shall agree that, if aggrieved, they will resort only to the remedies referred to in this Regulation, and whether those remedies are exhausted or not, will not resort to any court or other tribunal*

B.4 General Qualifications required of all International Race Officials

31.9 *A candidate for appointment or re-appointment for any discipline shall*

- (a) *except in the case of International Measurers, be an experienced racing sailor;*
- (b) *have a sufficient knowledge of the Racing Rules and a detailed knowledge of the rules, manuals and other requirements and publications relating to his discipline;*
- (c) *be proficient in the English language and have the skills to communicate both with other race officials and with competitors on matters relating to his discipline;*
- (d) *display the temperament and behaviour expected of an International Race Official at an event;*
- (e) *have the health and physical capacity to fulfil the requirements of his discipline;*
- (f) *have the observation skills necessary to perform the duties of his discipline;*
- (g) *agree to support the policies of ISAF and further its objectives, Rules and Regulations;*
- (h) *have unimpaired eyesight and hearing, natural or corrected, at a level to enable him to carry out the duties of his discipline; and*
- (i) *be able to contribute to the development of the programme relating to his discipline.*

31.10 *Where a candidate is required to have served at an event outside of his Group or Member National Authority the following provisions shall apply:*

- (a) *If the event is the Olympic Sailing Competition or a major event as designated by Regulations 25.12.17 (a) it will qualify as such an event even if it has taken place inside his Group or Member National Authority;*
- (b) *if the candidate is from Groups A-H, the event shall be outside his Group;*
- (c) *if the candidate is from Groups I-Q, the event shall be outside his Member National Authority.*

Additional Qualifications for Individual Disciplines

31.14 International Race Officer

31.14.1 *A candidate for first appointment as International Race Officer shall have complied in the 4 years prior to 14 October of the year of application with the following:*

- (a) *have served as Race Officer responsible for the management of the races on the water in four principal events; Notwithstanding this requirement, a candidate may count no more than two events in a 4 year period at which he/she served as an International Technical Official (ITO) on the race management team at the Olympic Games, Paralympic Games or Youth Olympic Games, or as Principal Race Officer (PRO), Deputy Race Officer (DRO), Course Representative (CR) in events listed in Regulation 25.8.17(a) and (b).*
- (b) *have served as Race Officer responsible for the management of the races on the water in four other events;*
- (c) *include with the application a letter of recommendation from a class association or organizing authority of a principal event at which the candidate was a race officer responsible for running the races;*
- (d) *have knowledge of matters affecting the safety of competitors in respect of race management;*
- (e) *have experience in race management training;*
- (f) *have attended an ISAF Race Management Seminar and have passed the International Race Officers written test within the four years prior to 14 October of the year of application; and*
- (g) *be prepared to work with the Race Management Sub-committee on race management matters; and*
- (h) *have obtained three completed RMSC reference forms (on the water assessment) from International Race Officials.*

31.14.2 *A candidate for re-appointment as an International Race Officer shall comply with the following:*

- (a) *the requirements set out in Regulation 31.14.1 with the exception of 31.14.1(f) and (h);*
- (b) *have completed eight on-line International Race Officer Regatta Report Forms in the role as described in 31.14.1 (a) and (b) and sent digitally to the ISAF office. (This to be phased in over the next 4 years 2013 -2016 on a pro rata basis).*

B.5 Considerations for Appointment

31.15 *Each sub-committee shall consider the following when deciding on an application:*

- (a) *whether the candidate has complied with the requirements listed above;*

- (b) *any comments received by means of Regatta Report Forms;*
- (c) *the candidate's relevant experience in other disciplines; and*
- (d) *such other information as it may consider relevant.*

31.16 Candidates for re-appointment who do not meet all the requirements for re-appointment, especially in respect of events attended, may, in special circumstances or on medical grounds, be recommended for re-appointment. In those cases, the Race Officials Committee may approve either:

- (a) *re-appointment of a candidate for a full 4 year term;*
- (b) *extension of the existing appointment for 12 months;*

31.17 Race Officials whose appointments have expired less than 12 months will be considered as candidates for re-appointment and shall meet the general and additional requirements for re-appointment for each discipline.

31.18 Race Officials whose appointments have expired for more than 12 months will be considered as candidates for initial appointment and they shall meet the general and additional requirements for initial appointment for each discipline.



ISAF RACE MANAGEMENT MANUAL

SECTION C

Qualities of an International Race Officer

Contents

Page

C	Code of Behaviour
C 1	Code of Behaviour

C 2

C.1 Code of Behaviour

ISAF International Race Officers serve the sport in positions which expose them to the critical eye of competitors, coaches, parents, spectators and others and it is therefore essential that Race Officers behave with the highest degree of competence, propriety, and integrity. At no time can or should a Race Officer do anything to bring the sport into disrepute or to reflect poorly on ISAF, their MNA or club or on other officials.

Specifically ISAF International Race Officers are expected to:

- maintain a high level of understanding and application of the rules, procedures and ISAF policies;
- ensure that each decision or action taken is based upon the rules and principles of fairness and objectivity, and is made with care and without prejudice;
- be responsible for their actions concerning the safety and welfare of competitors, race officials, support personnel and volunteers.
- uphold the confidentiality of race committee and jury deliberations during and after the regatta;
- be polite, courteous, open-minded, and patient with colleagues, competitors, race officials, team officials, support personnel, volunteers and hosts, and to respect cultural differences;
- declare, without delay, any apparent conflict of interest which may arise;
- arrive at the event in adequate time and remain until after all duties are completed;
- incur only expenses that are necessary, and when expenses are reimbursed, to claim only legitimate and essential out-of-pocket costs;
- maintain high standards of behaviour and good manners, including being on time, wearing appropriate clothing, refraining from inappropriate smoking, and maintaining only a moderate consumption of alcohol (total avoidance before important decision making).

A race official who does not adhere to this code may, after investigation, risks a sanction being applied by ISAF which can include termination of appointment.



ISAF RACE MANAGEMENT MANUAL

SECTION D

Reserved for future use



ISAF RACE MANAGEMENT MANUAL

SECTION E

Authority and Responsibility

E.1 AUTHORITY AND RESPONSIBILITY

Four authorities which usually govern major regattas are named as well as the committees which take the responsibility of organizing and running the regatta in line with the requirements of these authorities. Finally, the prime objectives of regatta organizers are discussed.

For most major regattas, four bodies share the authority.

The first of these is the International Sailing Federation (ISAF), which provides, revises and publishes every four years *The Racing Rules of Sailing* (referred to as 'Racing Rules' or 'RRS') under which the racing will be conducted.

Also with authority through the Racing Rules is the respective member National Authority of the ISAF. Through its prescriptions to the *Racing Rules*, it states how certain rules are to be interpreted or applied, and it may change some *Racing Rules* if considered appropriate and subject to RRS 86. Furthermore, it coordinates the dates and venues of national regattas, and may approve key regatta personnel such as the Regatta Chairman, the (Principal) Race Officer(s), and the Protest Committee Chairman.

The next body is the host club (or another organization). Affiliated to the national authority the club's input is generally through the Regatta Organizing Committee and this may be apparent through certain sailing instructions relating to local conditions.

Finally Class Associations will want to ensure that their class rules, both in terms of measurement and their established practice for regatta organization, are observed.

The involvement of all four bodies is usually apparent in those sailing instructions, which refer to the control of the regatta. (See, for instance, the heading of the Notice of Race guide –Appendix K – and the Sailing Instructions guide –Appendix L – of the RRS.)

One or more of these four bodies will singly or collectively become known as the Organizing Authority and will set up the Regatta Organizing Committee. It is essential that the Organizing Authority conforms to the requirements of RRS 89.2; otherwise, competitors will not have the protection of the *Racing Rules* or the appeal procedures provided by the National Authority. This is easily complied with by ensuring that a National Authority – affiliated club is nominated as the Organizing Authority. RRS 89.2 requires the Organizing Authority to publish a Notice of Race containing its name and further details (*RRS Appendix JI*) and (Appendix K –Notice of race guide RRS).

The Regatta Organizing Committee will accept responsibility, usually through a number of sub-committees, for all aspects of the regatta. Sometimes this committee is called the Race Committee, but this term is better retained for the sub-committee which has the important task of race control. Other sub-committees might deal with all the other varied aspects of organizing a regatta, such as measurement, social events, press and sponsor contacts, etc., and these are discussed in detail in Section F of this Section.

Throughout the organizing and running of a regatta, the Regatta Organizing Committee should remember that its prime objectives are to:

- (a) provide fair competition for all competitors;
- (b) ensure the regatta is run in accordance with the Racing Rules of Sailing and rules of other relevant authorities, when they apply;

- (c) ensure that all competitors can and do conform to the rules of the regatta;
- (d) as far as possible give satisfaction to all competitors.
- (e) ensure that sailing instructions are produced which follow the ISAF standards (see RRS Appendix L and ISAF website).

The safety of all competitors (see *RRS 1*) is a prime responsibility. It is the Regatta Organizing Committee's task to ensure that every person involved in the regatta is aware of the fact that safety comes first at all times. To ensure fair competition (see *RRS 2*), the Race Committee must set fair starting lines, courses, and finishing lines, conscientiously observe all rules and follow good race management practice.

The Racing Rules of Sailing, the prescriptions of the National Authority and the class rules stipulate the requirements to meet the third objective above. Rules compliance – in the broadest sense – by all competitors is vital, not only to ensure fairness of the competition, but also to maintain the high standing of the sport of sailing with the general public and not to bring the sport into disrepute (see *RRS 69*).

Ensuring that clear, unambiguous and comprehensive Sailing Instructions are written must be considered a major responsibility of the Regatta Organizing Committee, although this task would normally be delegated to the Race Committee.

Satisfaction to all competitors is perhaps the most difficult objective to achieve. It is in this area that considerable judgment and experience is required. The vagaries of wind and weather will usually cause difficulties for the Race Officer, and frustrate competitors. However, the effect of these can be reduced with foresight and by following the detailed planning and procedures advocated in this Manual.



ISAF RACE MANAGEMENT MANUAL

SECTION F

Committees and Key Personnel

Contents	Page
F Committees and Key Personnel	
F 1 Guideline plan for a major event organization	F 3
F 2 Regatta Organizing Committee	F 4
F 3 Race Office Organization	F 5
F 3.1 Entries and Registration	F 7
F 3.2 Reception and General Information	F 8
F 3.3 Results and Competition Information	F 9
F 3.4 Printing and photocopy support	F 10
F 3.5 Meteorology & weather reports	F 11
F 3.6 Race Office – Major Events	F 11
F 4 The Race Committee	F 13
F 4.1 ISAF or Class Race Officer	F 13
F 4.2 Principal Race Officer	F 13
F 4.3 Race Officer	F 14
F 4.4 Deputy Race Officer.	F 14
F 4.5 Assistant Race Officer.	F 14
F 4.6 Visual Signals Officer	F 14
F 4.7 Gunner/Sounder	F 14
F 4.8 Timekeeper	F 15
F 4.9 Recorder	F 15
F 4.10 Course-setter	F 16
F 4.11 Pin End Boat Crew	F 16
F 4.12 Beach Master	F 16
F 5 Judging - The Protest Committee	F 17
F 5.1 Protest Committee	F 17
F 5.2 Independent Protest Committee (Jury)	F 17
F 5.3 International Jury	F 17
F 5.4 Interaction of Protest Committee and Regatta Organizing Committee	F 18
F 5.5 Protest Committee duties	F 18
F 6 Umpiring	F 19
F 7 Measurement Committee	F 19
F 8 Safety Committee	F 20
F 8.1 Safety Officer	F 20
F 8.2 Personnel and equipment	F 20
F 8.3 Safety Operations Plan	F 20
F 9 Race Committee Vessels	F 21
F 10 Social Committee	F 21
F 10.1 Social activities	F 21
F 10.2 Opening ceremony	F 21
F 10.3 Closing ceremony	F 22
F 11 Press & Publicity Committee	F 22
F 11.1 General	F 22
F 11.2 Relationship with media	F 23
F 11.3 Press Office and facilities	F 23
F 11.4 Press and TV boats.	F 23
F 11.5 Press accreditation	F 23
F 12 Sponsorship Committee	F 24
F 12.1 General	F 24
F 12.2 Amount of sponsorship	F 24

F 12.3	Attracting sponsors	F 24
F 12.3	What can you offer the sponsor?	F 25
F 12.5	Contracts	F 25

This chapter is about the committees and the key personnel in charge of a regatta outlining their tasks and responsibilities. Not only is the Race Committee dealt with, but also the Protest Committee and the Safety Committee. How to build the relationship with the media and how to attract sponsors is discussed at the end of this chapter.

F.1 Guideline plan for a major event organization

Good organisation is the key to a successful regatta. This plan is a guide to the management structure for a major event. The committee structure will vary according to the needs of the event, its size and its status.

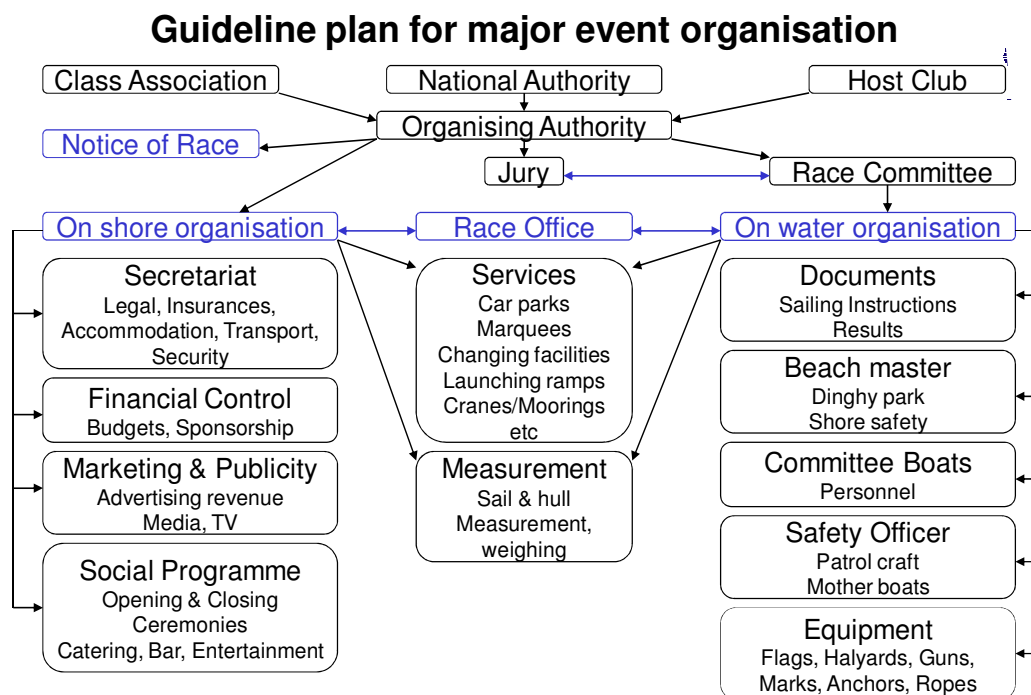

Organising Committee structure

The Organising Committee is responsible for all aspects of the event. It will appoint several subcommittees to oversee particular aspects of the event.

For many smaller regattas, some of the functions will be combined into one sub-committee.

On Shore Organisation and Facilities

This section of the organisation covers all the ‘onshore facilities’ and their organisation and management.

The following sub-committees are suggested as a basis from which a good management structure can be evolved:

- Secretariat – Legal; Insurances; Accommodation; Transport; Security
- Finance – Financial control; Budgets; Sponsorship
- Marketing and Publicity – Advertising revenue; Media and TV; Press

- Social – Opening and Closing Ceremonies; Entertainment programme; Bar facilities; Catering
- Services – Car parks; Trailer and Container parking; Changing and Shower facilities; Toilets; Launching Ramps and/or Cranes; Moorings; Additional covered areas using large tents; etc.
- Measurement – Covered area for sail and hull measurement; weighing scales.

On the water facilities and Equipment

- Documents – Notice of Race; Sailing Instructions; Protest forms; Results; etc.
- Beach Master – Shore official signal mast; Control of dinghy parking and launching; Shore safety
- Committee Boats – Personnel; Suitable craft
- Safety Officer – Patrol craft; Safety evaluation; Safety plan; Mother boats
- Equipment – Flags; Halyards; Sound Signals; Marks; Anchors; Ropes; etc.

F.2 Regatta Organizing Committee

The Organizing Authority is charged with the whole organization of the regatta, on and off the water and including the all-important balancing of the books. It will appoint a Committee, which will probably consist of six to twelve members. This Committee derives its authority in terms of *RRS* from the affiliated club or association that set it up, and to that organization it is ultimately responsible for the whole conduct of the regatta. Some of its members will be conveners of the various sub-committees referred to below. It will have its first meeting at least six months and possibly more than a year before the regatta begins.

Once the regatta is under way, it takes all decisions relating to the event, except those delegated to the Race Committee. It needs a competent, experienced Regatta Chairman (see below) who is ready to answer for whatever occurs in the name of the Regatta Organizing Committee.

The Regatta Organizing Committee's principal pre-regatta functions are:

- to prepare and issue the Notice of Race (*RRS* 89.2.); and to ensure that it is issued to all potential competitors and relevant associations, clubs, and national authorities. If appropriate the NOR should be posted on the host authorities web site. In the case of major events complete details should be forwarded to ISAF for inclusion in their publications and web site together with details of any links to the host web site. The NOR shall include an entry form and a closing date (see *RRS* appendix K). The closing date should be as close to the regatta as possible but also to allow sufficient time for the organizing committee to properly plan for the number of entries received.
- to appoint sub-committees or personnel for the following (see *RRS* 89.2):
 - measurement + safety checks;
 - on-the-water Race Committee(s);
 - jury, when appropriate;
- to ensure that all the equipment and facilities required for the regatta are available and functioning;
- to approach harbour authorities, coast guard, meteorological offices and any other organization, cooperation with whom will lead to a more successful regatta.

Regatta Chairman

The Organising Committee needs a competent, experienced Regatta Chairman, who is ready to answer for whatever occurs in the name of the Regatta Organising Committee. This is the person who sets the deadlines and ensures that all sub-committees work to those deadlines. The Regatta Chairman will play a prominent part in staging the regatta, and must be knowledgeable in race management. The Chairman has special responsibilities which, exercised in consultation with his Regatta Organising Committee, may be summarized as follows:

- contribute to the planning and decision-making relating to the on-and-off-the-water conduct of the regatta;
- convene the Regatta Organizing Committee when necessary, perhaps even at the end of each day, to confirm results and review the organization and procedures, so that whatever changes are necessary in the interest of fairer racing can be made immediately.
- The Regatta Chairman may hold any one of the positions listed below. However, in big regattas, the Regatta Chairman will have a heavy enough task coordinating the event not to be assigned any specific on-the-water duties.

F.3 Race Office Organization

The race office is the administrative centre of the regatta. For organisation purposes we'll divide it into a 'front office' and a 'back office'.

The 'Front' Office (sometimes identified as 'information desk' or 'competitors desk') is the first point of contact between the organisation and their guests: competitors, coaches, press, general public, etc. The role of this team is fundamental and must convey an image of efficiency and goodwill.

It is important that the personnel selected for staffing this position are of an out-going, friendly nature.

Its size depends on the size and level of the competition.

This will also be the point of contact for the press and media, from where they will receive all the information they require. For very large events a separate Media and Press centre will be required.

The front office should also have instant access to the emergency services.

- A 'front office' should deal directly with the competitors
- receipt of entries;
- reception;
- registration and information;
- results and information
- publish notices on the 'Official Notice Board'
- display signals on the 'Official Signal Mast'

The 'Back office' which should have access restricted to a few key personnel.

The results will be processed here.

This is where the Race Committees and the Class Association representatives can meet as required.

A 'back office' should be restricted to officials

- printing and photo copy support;
- meteorology and weather reports.
- Meeting room

Both offices should be well equipped to deal with any administrative work which may arise. The race office should have all the necessary items found in any efficient office; counters with chairs; word processors; file cabinets; staplers; paper clips; hole punchers; pencils; highlight markers; erasers; ruler; scissors; paper; glue; note pads; self-adhesive labels; binders; safe; information board; whiteboard and markers; pigeon holes (alphabetical for mail and messages); organization's stamp; telephones; fax; internet connection; telephone log; clock; translation dictionary.

Besides the above functions, the race office is in charge of three key tasks during the regatta:

- the Official Notice Board;
- the Official Signal Mast;
- marine data for the racing area.

Official Notice Board

The Notice Board is one of the most important functions for the race office to perform. Is the preferred mechanism of communications to competitors: all the official notices, official information, competitor's groupings, results, protest information, etc, is posted here.

All relevant notices must be in writing, for its good comprehension and to keep adequate records.

Official Signal Mast

One of the responsibilities of the staff in the race office, is to display visual signals, and make the appropriate sound signals, on the official signal mast on shore. All these signals should be authorised by the Race Officer (or the Principal race Officer).

In many large regattas, this job is allocated to the beach master by the Secretariat. Only one person should operate these signals so that a standard practice is followed.

Preferably a full set of flags should be available at the Race Office, but at least the following:

- codeflags "A", "H", "L", "N", "Y", "AP";
- numeral pennants 1- 6;
- appropriate class flags and/or racing areas signals;
- loud sound signal device (horn or gun).

Marine data for the racing area

It is very important that a local map or chart, showing the location of the race areas is provided.

Tide tables, when appropriate, showing the times of high and low water, and the heights of the tide, should also be published early.

If the information is available, then the strength and direction of currents should be published on the local map or chart.

Water temperature is an important factor for competitors. This enables them to prepare with the correct type of clothing suited to the racing conditions.

Advice as to the type of sea conditions that are likely with a particular wind direction also helps the competitor.

Much of this information will also be required by the Race Officer well in advance, particularly, as frequently happens under the ISAF Regulation 18, when the Race Officer appointed, is not local.

Race Office functions

Here below is a list of the main functions to be performed by the race office.

F.3.1 Entries and Registration

Before the Regatta

- Receive all pre-registration documentation; entry forms; entry fees
- Prepare documentation to be handed out to all parties
- Set up a Notice Board with an Official section for Race Committee, Protest Committee; Measurement Committee.
- Also provide a separate section for meteorological information, social programme and miscellaneous communications.

During the days reserved for measurement and inspection

- Establish the final participation list; Participants must confirm and pay entry fees
- Attach the following documents to the Official Notice Board: Notice of Race and Sailing Instructions; nautical chart showing course and distance to the centre of the race area(s); amendments to the Sailing Instructions, if any; composition of Race Committee, Jury, Measurement Committee; list of competitors; Measurement Instructions; Measurement schedule. When applicable Coach Boat Regulations.

Accreditation

- Issues accreditation passes to all those entitled to be in the venue. This may require photographs being taken for inclusion in the accreditation pass.

On competition days

- Open the Race Office at least 3.5 hours before the first starting time scheduled
- Post the meteorological information

- Post any Notices, Amendments, etc. on the official section of the Notice Board
- Prepare documentation per race for the Race Committee and Jury
- Monitor the use of the sign-out sheets
- Post the "provisional" finishing order and results

On completion of the days racing

- Post list of premature starters per race per class
- Post the end of Protest Time for each class
- Have available and receive (noting the time): retirement forms; 360 + 720 declaration forms; protest forms; change of equipment request forms.
- Monitor the use of sign-in sheets
- Post protest hearing schedule
- Prepare copies of protests for the Jury and protestees
- Page parties to the protests when required
- Post protest decisions
- Replace "provisional" results with "confirmed" ones on the Notice Board
- Finalize the file of each race with copies for the Race and Protest Committees
- When closing the Race Office, leave a note saying at what time it will open again

F.3.2 Reception and General Information

Before the regatta

Obtain the following information:

- local services: post office, police, etc.;
- list of hotels, bed & breakfast, motels, campgrounds (including rates), restaurants, bars, discos, etc.;
- list of personnel and competitors with lodging information (where to reach them);
- list of consulates or embassies of the competing nations;
- travel agencies, car rentals;
- customs agents;
- local map with points of interest;
- transportation information: airports, railroads, buses;
- phone books, church schedules, where to buy foreign newspapers, etc.

For competitors

Prepare documentation folders to include any of the following;

- Sailing instructions;
- Weather and tidal information
- postcards of regatta posters;
- local map;
- social programme + tickets to social functions;
- regatta poster;

- tickets for various functions;
- regatta shirts;
- promotional material.

For coaches and team leaders

In addition to the competitors' documentation:

- schedule of meetings;
- instruction for the use of facilities;
- map of the race area;
- List of competitors, plus any other relevant information

See Appendix F2 to this manual “Reception and Information team tasks”

F.3.3 Results and Competition Information

The ‘Back Office’ deals with

- Processing results sent in by the Race Committee’s
- Processing protest hearings with the Jury Secretary
- Processing any measurement issues from the Measurer

Location

The Results and Competition Information team will require a large enough room to comfortably accommodate all the equipment. It must have direct access to the Race Office and the secretary of the Protest Committee.

To enhance accuracy and efficiency, the Results Room is usually labeled as a limited access area.

Before the first race of the regatta

Record all possible data such as: entry forms, collection of entry fees, competitors' contact location and telephone, etc., so that at the end of the registration period the following documents can be compiled and processed on a computer, if required:

- list of competitors (by country, by sail number or by name);
- listing of requirements not yet complied with by any competitor (entry fee, measurement certificate, etc.);
- individual dossier cards (nationality letter, sail number, bow number, competitor's first and last names, birth date, height, weight, blood type, past results, etc.);
- data for making competitors' accreditation cards.

After measurement

The following data should be available:

- listing of any boats that have not yet complied with all measurement requirements;
- data on materials measured (hull manufacturer, sail maker, spar makers, etc.);
- technical data (balancing test, corrector weights, etc.);

- graphs of the materials used, graphs (bar-type) of technical data on measurements, age, professional background, etc.

After each race

Produce all the documents connected with race results:

- preliminary finishing order of each race and overall results so far;
- order of mark roundings and graphs of the development of the positions at each rounding;
- final results of each race after Protest Committee decisions and overall results so far;
- listing of Race Committee data: class, race, number of competitors, starters, finishers, course length, starting time, time limits, compass bearing(s) to the windward mark, wind velocity, atmospheric pressure, wave height, visibility, air temperature, etc.).

After the last race

The team's final report should include all the collected regatta statistics for officials, competitors and support personnel:

- results of each race;
- mark roundings;
- overall final results;
- report on materials (hulls, sails, masts, etc.);
- measured data of interest and related graphs (balancing tests, turning radius, centre of gravity, etc.);
- report on the races, winds, currents, waves, etc.

Equipment needed

- computer, keyboard, screen and printer for each race area;
- carefully tested computer programs;
- radio communications for each area;
- paper supplies;
- tables and chairs;
- blackboard or bulletin board;
- office supplies as requested.

F.3.4 Printing and photocopy support

One heavy-duty photocopier in the Race Office will usually be sufficient, but more support may be required. The fast dissemination of results enhances the Race Office's level of efficiency and is always greatly appreciated by all.

See Appendix F3 to this manual “Printing and photocopy support“

F.3.5 Meteorology & weather reports

The importance of this section depends on the type and level of competition, and the type of race area(s). It is most relevant in race areas not well known or tested, which will demand that the organization supply the competitors with good local weather information.

The inclusion of meteorological data with the Notice of Race is recommended.

During competition the services of a specialist in micro-meteorology, or the local or national meteorological service, should be procured to provide a daily weather report. This daily report should be put in the meteorological section of the official Notice Board, at least three hours before the Preparatory Signal. It is important to retain on the board the previous days' reports to allow a reference to the evolution experienced at least in the isobaric pattern.

Briefings

For major regattas, two daily briefings are recommended:

1. One is for the Race Committee(s), before going afloat, giving them a detailed forecast for their area.
2. The second briefing, with the same content, is the one for competitors and/or coaches, at least two hours before the start.

The type of information to be supplied at the briefing depends on the type of races and the type of boats that will be competing.

See Appendix F4 to this manual "Meteorological data"

F.3.6 Race Office – Major Events

Communications

During important events with several course areas and many competitors it is important to know the status of everything that is happening on all the course areas and with the event. This can be done with a coordinated communication network (radio or telephone) and staff grouped in a centralised Race Office. The team is led by the PRO and is called the Race Management Team (or Race Management).

The reasons for creating this centre are:

General Co-ordination

The overall event is controlled by the PRO from this office and allows for the centralisation of all information concerning the event. The PRO should act in consultation with all the course area Race Officers to ensure that consistent decisions are made in all areas and to provide the appropriate assistance, backup and support for the Race Officers if and when they require it.

On Water Safety

The Race Office should be the central area for obtaining weather information, forecasts and updates and they should ensure that this information is passed on to all Race Officers and that they are kept up to date with regular weather information. It is in the Race Office that

decisions are made by the PRO in consultation with the Race Officers whether to go on the water, to delay or postpone races in respect of each class or course area. As a consequence of this, it is the Race Office that co-ordinates all the onshore flag signals, whereas once it is decided to race, the on water decisions are generally made by the course Race Officers. Should there be an incident or accident during the event it is the Race Office that should instigate and co-ordinate the appropriate response and assistance. In the case of a serious problem it is important that the Race Office can be secured and isolated so that whatever actions need to be taken can be carried out without interruption or interference.

Information

When setting up the office, the media should be allocated their own area separate from the Race Office and they should be given regular meaningful updates so that they have no need to come into the actual Race Office and pester the Race Officials for information.

The information to be made available should include:

Courses to be sailed

Starting times

Wind strength and direction

Number of individual recalls (including sail numbers and whether they started correctly)

- General recalls
- Black flags and sail numbers of any boats penalised
- Actual starting times
- Mark roundings and times
- Details of any incidents of interest
- Finishing order and times
- Protest time limit(s)
- Protest schedules and results
- Individual and progress race results and standings

This information can be supplied by computer screen, internet, website or in printed format.

The Race Office

The ideal Race Office would have a view of the launching areas and also the race course areas. It should be large enough to accommodate all the personnel and equipment required, it should also be well ventilated and as soundproof as possible.

Equipment

The equipment should include at least one radio on each course area operating on a separate dedicated radio channel for direct contact with the Race Office where the PRO has his own radio tuned to that channel (there could also be an extra one in the Race Office for general use), this avoids conflict with general on course race operations which are carried out on a different channel. The use of mobile phones can also be of an advantage. A large whiteboard or similar to keep track of situations is also handy while the information is input on computers so that it can be disseminated to the media, officials and others. Naturally, the appropriate computer equipment should be installed.

Personnel

The Race Management Team should be made up of experienced personnel who have a good knowledge of race management and the event and therefore the confidence and trust of the Race Officers. They should also know the extent of their authority to make decisions before involving the PRO.

F.4 The Race Committee

All sub-committees have important roles in a successful regatta but probably the most important is the Race Committee, appointed by the Organizing Authority. The Race Committee is responsible for what does or does not take place on the water. It runs the races.

The Race Committee shall publish written Sailing instructions that conform to the Appendices in the *RRS*. They will then conduct and score the race or series as required in the *RRS*.

The Chairman of the Race Committee may, but preferably not for a major event, be the Principal Race Officer.(PRO). He liaises closely with the Race Officer(s) who is (are) the "on-the-water manager(s)". He supports and directs them off the water and authorizes changes to the Sailing Instructions. An International Race Officer (IRO) will be appointed for major events by the ISAF.

In the following sections we will refer to "the Race Officer", "the Gunner", etc. In the case of a regatta with more than one race area, these positions exist, of course, for each separate race area. The list of equipment required is given in Appendix F5 to this manual "Race Committee vessels and equipment for major events".

F.4.1 ISAF or Class Race Officer

This person is either appointed by the ISAF or by the Class Association.

The ISAF of Class Race Officer has two main roles.

- To act as an advisor to the Race Officer on what the Class race management guidelines are and how they should be implemented
- To oversee the fairness of the competition and that there is no favouring of the local entrants.

F.4.2 Principal Race Officer

If there are multiple courses being used at the same time, the overall on water management of the regatta is the responsibility of the PRO who liaises with the race officer on each course. (If there is only one course it is managed by a Race Officer and there is no PRO). The PRO keeps an overview of all courses and is the ultimate decision maker on the overall conduct of the event. This includes such matters as to whether the weather conditions are suitable for racing, while the Race Officer is responsible for the actual conduct of the race on his course. It is therefore important that the PRO is a very experienced Race Officer and that he is recognized as such. The PRO also supervises the onshore aspects of race management, ensuring that signals are displayed correctly, notices are placed on the official notice board, etc. The PRO will liaise closely with the Regatta Chairman.

F.4.3 Race Officer

Ideally, the Race Officer is an on-the-water manager, who lets his team get on with the job without interfering, although he should take the decisions regarding boats on the course side of their starting line, course changes, etc., himself. The advantage is that he can at all times keep an overview of what goes on around the entire race course. If appropriate, he will liaise closely by radio with other Race Officers on nearby race courses, and with the Principal Race Officer. The Race Officer and the Assistant Race Officer should record all their actions on tape recorders for later reference. The tape recorders should be left on during all start, recall and finishing procedures. As the responsible person for his race course, he will usually represent his Race Committee at protest hearings, although he may prefer to appoint a delegate. At high level events it may be required that he is an IRO or a National Race Officer (NRO)

Before the first race he will brief his Race Committee on their jobs, making certain that all tasks are covered. He also ensures (whether or not through delegation) that all the necessary equipment is available and functioning.

He may wish to appoint an assistant Race Officer on the Line boat at the pin end of the starting line, who will help him identify boats on the course side of their starting line by radio.

F.4.4 Deputy Race Officer.

A person, working on the main committee boat with the Race Officer, who would be capable of taking over as Race Officer in an emergency.

Under normal operating conditions, with the appointed Race Officer present, the Deputy Race Officer would organise the committee boat personnel to ensure that everyone is in position and ready to proceed.

F.4.5 Assistant Race Officer.

Normally placed on the Pin End line boat. The ARO works closely with the Race Officer, particularly when setting and then later, sighting, the start line.

F.4.6 Visual Signals Officer

The Visual Signals Officer will be responsible for ensuring the visual signals are ready for display at the appropriate time. This officer should have a knowledge of all the visual signals as illustrated in the 'Race Signals' section of the *RRS*, when to use them, what message the signal is sending to the competitors and equally important, when to remove a signal that is displayed.

He takes all his timings from the Timekeeper.

F.4.7 Gunner/Sounder

The Gunner/sounder is also closely attuned to the Timekeeper and has responsibility for all the sound signals that accompany the visual signals.

If guns or other fire arms are used to make sound signals, it is the responsibility of the Gunner to ensure the safety of their use for him and his fellow committee members on board

as well as for the competitors. Even blank shells can cause serious damage when fired at close range. The Gunner must thoroughly familiarize himself with the operation of his guns, particularly with regard to reloading after firing a shell.

Nowadays, some Organising Committees try to substitute guns by very loud horn signals. That could save costs, but experience shows that it is better to use a gun for the starting signal, particularly when the start line is very long. For shorter start lines air horns are more than adequate

F.4.8 Timekeeper

This is, after the Race Officer, the most important position on the Race Committee. More starts have been spoiled by the Timekeeper being distracted by unnecessary chit chat than any other single cause. It is a position which requires single-minded concentration and a good clear voice. The dead-line for the day is the START of the race. Calling the count down in minutes and seconds to each signal should be made clearly, so that all Committee Boat staff are aware of the time remaining to the start. The same procedure should be used throughout the countdown.

The countdown should be: "One minute to warning signal; 30 seconds to warning signal; 15 seconds; 10; 9; 8; 7; 6; 5; 4; 3; 2; 1; Now!"

The tasks of Gunner and Timekeeper may be combined if the person appointed as such is competent and confident enough to fulfil them both.

F.4.9 Recorder

The Recorders are responsible for the paper work on the water. There are several duties for the Recorders to do during the time the Committee Boat arrives on station.

- note the competitors reporting at the start;
- keep the log of actions and communications;
- wind direction and strength; course used;

all noted against the appropriate time. In other words, a good Recorder compiles a diary of the race.

A Recorder should also note all the boats identified by the Race Officer or his delegate, as being on the course side of the starting line at (or during the minute before) her starting signal. If any of the Penalties described in the *RRS*, are used, the numbers of the offending boats should be noted. When a boat is allowed to correct the error and does so within the *RRS*, then this is also noted by the Recorder.

The Recorder should ensure that he has a back-up person to record those boats on the Pin End boat.

When recording the finishing order, there should be a back-up on both at the pin end and on his own boat. If the Starting vessel does not also act as Finishing vessel, the Finishing vessel, too, should have two Recorders and a back-up at the pin end. Tape recorders should also be used to record finishing positions as they are called while actually crossing the finishing line. This is very handy for sorting out any confusion later on particularly where a lot of boats have finished in a close group.

F.4.10 Course-setter

Many Sailing Instructions now have a 'Target Time' for the first boat to finish. This is different to the Time Limit. The Course-setter needs to be able to set an accurate course following the Race Officer's directions regarding wind strength and direction. Knowledge of boat speed in different wind strengths is essential in being able to set a course of the correct length to achieve the target time.

Course changes, too, can be easily calculated with this information.

With the much shorter race duration, some classes do not want course changes made. Where classes request that this is to take place, then the Course-Setter has to anticipate the needs of the RO and have all the relevant information to hand (magnetic bearing and distances) so that marks can be moved and re-laid as soon as possible

Ideally he should have enough information, nautical skills and the necessary equipment (course illustrations, compass, anemometer, sea charts, GPS) to operate on his own and to advise the RO accordingly. His contact with other Course-setters when there is more than one race area is essential. His judgment can have a decisive influence on the success of the race.

F.4.11 Pin End Boat Crew

The person in charge of the pin end line boat and its crew is normally the Assistant Race Officer.

A boat at the pin end of the starting line instead of a pin end buoy is recommended at major events. The crew of this vessel are required to judge the starting line and to very quickly communicate with the RO what they have recorded in the way of boats 'On The Course Side' (OCS). It is important to emphasize that they act in an advisory capacity only. The decision as to which boats are over, or if the line is 'clear' (no boats over), rests solely with the RO.

It is therefore very important that the ARO on this boat is well experienced in RC operations. He should also record everything on his tape recorder.

F.4.12 Beach Master

The responsibilities of this officer can be as varied and as onerous as he likes to make them, but the contribution of him and his team to the success of a regatta can be tremendous. He is one of the principal shore-based officials.

Prior to the event, the Beach Master should know the estimated number of keelboats competing and their place of mooring; the amount of dinghy parking needed; the amount of space required for RC boats, Patrol boats, coach boats, etc. His tasks include ensuring the orderly and systematic launching of boats, lending a hand when it is reasonable to do so, retrieving boats on return, ensuring that any allocated spaces are occupied, advising on where assistance might be obtained for repairs and replacing equipment, perhaps even holding a few tools himself and a willingness to produce them.

He also takes care of important safety checks such as noting who has and has not entered the water, and similarly, from beach trolleys and cradles still vacant, who is still to return. When a signing in and signing out system is in use (or a tally system), it is the Beach masters job

to operate the system and collect any fines. He should report these actions to the RO. It is helpful for the Beach Master to have radio contact with the Race Officer even when this is additional to the main shore-based radio. He should advise the Race Officer when the last boat leaves the beach. He should be able to advise the RO of the expected number of boats in the starting area.

F.5 Judging - The Protest Committee

The term "judging" is used in the sport of sailing to include a wide range of services to competitors, including the hearing of protests and requests for redress, deciding questions of eligibility and boat measurement compliance, and being present on the water watching for rule infringements - especially the illegal propulsion rules.

The term "Protest Committee" is used to describe the body which conducts the hearings, whether it be a committee appointed by the Organising Authority or the Race Committee, or an International Jury appointed by the Organising Authority and conforming to Appendix N in the RRS.

The degree to which an organiser should provide a full range of judging services to competitors very much depends on the type of event being conducted.

F.5.1 Protest Committee

A Protest Committee may be appointed by the Organising Authority or the Race Committee to hear protests and requests for redress. This type of Protest Committee is only suitable for club level racing.

F.5.2 Independent Protest Committee (Jury)

At an "open" event to which sailors come from other clubs, it is desirable for the Organizing Authority to appoint an independent Protest Committee (known as a "jury") but not to be confused with an "International Jury"); independent, that is, of the Race Committee, and, if possible, made up of people from different clubs.

The independent Protest Committee's job is to ensure that competition is fair; its members are often afloat during racing and will initiate protests when they see rule infringements of a nature that affects the fairness of the competition.

Many National Authorities have a National Judging scheme and appoint National Judges and some require that at national events, the membership of an independent Protest Committee includes a majority of National Judges.

F.5.3 International Jury

An International Jury should be appointed by the Organising Authority in accordance with the *RRS Appendix N*.

This appendix specifies in detail, the composition and authority of an International Jury. Appendix N cannot be altered by a Sailing Instruction or a MNA Prescription.

F.5.4 Interaction of Protest Committee and Regatta Organizing Committee

When the Race Committee produces the first draft of the Sailing Instructions, these should be sent to the Chairman of the Protest Committee or International Jury. This is so that the Chairman can interpret and if necessary, correct the wording, so that there will not be confusion between the Race Committee and the Protest Committee during the event. The Protest Committee should limit its comments to interpretation. The method of working, as described in the Sailing Instructions, is strictly the province of the Race Committee. This avoids lengthy debates at the initial Protest Committee meeting on location and long lists of "Amendments to the Sailing Instructions".

It is important to schedule a meeting between the Protest Committee and the PRO/RO prior to the first competitor/coach meeting.

The use of the standard *RRS* Appendix L 'Sailing Instructions Guide' avoids many problems and helps minimise subsequent debate and discussion (*RRS* Appendix LE is an expanded version of Appendix L containing provisions applicable to even the largest and most complicated multi-class events, and variations on several of the sailing instructions found in Appendix L. This version includes sailing instructions for the Medal Race Concept. It can be download from <http://www.sailing.org>)

Information on and arrangements for lodging, transportation and regatta location must also be provided well in advance. If appropriate the Regatta Organising Committee should ensure that the arrival schedules of the Protest Committee members are known in order to Organise the pick-up from airports, railway stations, etc.

F.5.5 Protest Committee duties

Once the Protest Committee has arrived at the venue, they should meet to discuss the following:

- their authority and role;
- nomination of (vice-)chairman and, if appropriate, panel chairmen;
- delegation of areas of responsibility to members;
- protest policy
- appointing one member as scribe if no Secretary is available.
- Notices by the Protest Committee, correctly numbered and signed by its Chairman (and, if appropriate, also by the Regatta Chairman, PRO or RO) go to the Protest Committee Secretary, who distributes copies to the Notice Board, the Race Officer and the Race Office. The original is to remain with the Secretary.
- It may be convenient to arrange for a preliminary meeting between the Regatta Chairman, the Race Officers, the head of the Race Office, the Protest Committee Secretary and any other key personnel to discuss:
 - on-the-water procedures (course changes, limitations on racing, etc.);
 - the procedure of processing the protests;
 - (changes to) Sailing Instructions, if any;
 - any reports of the Race Committee to the Protest Committee;
 - Protest Committee Race Committee relations;
 - radio procedures;

- Protest Committee equipment.
- These days most Protest Committee members go out to the race course to familiarize themselves with the courses and the types of boats sailed, and to observe the weather conditions in which the races are conducted. Depending on their policy they may want to actively monitor rule infringements on the water. In order to do their job, they should be supplied with adequate boats, usually rigid inflatables adequately equipped for a long period on the water.
- For further details on recommended Protest Committee procedures, see the ISAF Judges Manual.

F.6 Umpiring

Umpiring and On the Water Judging

This is now a standard feature of all major events.

There are separate Appendices in the *RRS* covering each of the following;

- Match racing – RRS Appendix C
- Team racing – RRS Appendix D
- Fleet racing – RRS Appendix P
- Umpired fleet racing – RRS Appendix Q
- Medal Race – RRS Addendum Q

To enable umpiring and on the water judging (umpired fleet racing) to be effective, the Organising Authority are required to provide suitable boats, flags, radios, etc. The large RIB (rigid inflatable boat) is ideal, being fast, manoeuvrable and having all round vision. In sunny climates some form of shade should be supplied.

The recommended procedures for the preparation of umpired match and team races are described in the ISAF Umpiring Manual.

The RRS Addendum Q may be downloaded from www.sailing.org.

For further details in Match Racing race management see Section T of this manual.

F.7 Measurement Committee

The Organising Authority of a major event may appoint a Measurement Committee or a Measurer to measure boats, either as a part of a standard across-the-board measurement procedure, or in case of a dispute about measurement. It would be usual for a Protest Committee to consider this Measurement Committee or Measurer to be the "qualified authority" to which it would refer a measurement question.

The National Authority's Chief Measurer for the class(es) concerned may be a member of the Measurement Committee. At International Class Championships an ISAF Class Measurer is usually in charge of measurement procedures. The Chief Measurer will require a sufficient number of competent personnel to handle all the measurement requirements. For pre-regatta measurement, depending on the relevant Class Rules, these will e.g. include scantlings, design and construction, fitting accessories, sail measurement and weighing. Often a jig is required for rapid, efficient assessment of design compliance. Post-race checks

by the Measurer and/or members of his team may include checking buoyancy aids, other safety equipment and the weighing of wet clothing.

In order to have sufficient crew, equipment and suitable space for efficient measurement at the start of the regatta, communications between the Chief Measurer and the Regatta Organising Committee at an early preparation stage are essential. The responsibilities of the Measurer or Measurement Committee may include carrying out checks (such as sails set within black bands, distribution of ballast, weight of clothing, etc.) on boats, usually immediately after finishing. The Measurer is a member of the regatta committee and reports direct to the Regatta Committee.

F.8 Safety Committee

F.8.1 Safety Officer

The Race Committee should appoint a capable Safety Officer, who will be responsible for safety and rescue operations. He must be familiar with the regatta venue, with the characteristics of the class(es) competing and any applicable governmental or similar rules. The cooperation with local or private non-profit Rescue organizations is highly recommended.

The Safety Officer must be familiar with the safety regulations under which the regatta is being sailed, that is to say the safety requirements of the National Authority, of the Class rules, of the Sailing Instructions and of any authority over the regatta water such as the local harbour board.

It is highly desirable that any possible conflict between these be resolved before the regatta and that the Sailing Instructions give the final word, including resolution of any conflict.

F.8.2 Personnel and equipment

F.8.3 Safety Operations Plan

Patrol Boat Crews

The crew of a Patrol boat should consist of 2 persons. Preferably each patrol crew member should:

- be 16 years or older;
- be a good swimmer;
- have knowledge of safety and rescue operations;
- be experienced in the operation of Patrol and sail boats;
- have racing experience.

Number of Patrol boats

This depends on the competition level, age and number of competitors, etc.

Patrol Boat

The Patrol boats should be inflatable or semi-rigid, of more than 4 metres overall length, with a motor of adequate power for the boat length and powerful enough to tow several boats (minimum 20-25 hp). Sometimes, especially if the distance from the racing area to the

harbour is considerable, Patrol boats are not allowed to tow competitors boats back to the harbour. In this case you should arrange for additional, other, perhaps bigger rigid boats, to do the job of towing several (damaged?) boats over that distance.

Mother boat

The Mother boat manoeuvre to seaward of the race area. The Patrol boats will bring rescued boats and competitors to this boat, thus avoiding the moving of the Patrol boats to shore. If the Safety Officer is not in one of the Patrol boats, he will be on the Mother boat. The Mother boat will also have a doctor or adequate first-aid personnel on board.

When there are several race areas at the same time, a base ashore can help to coordinate Patrol boats, Patrol personnel, supplies or ambulance assistance.

See Appendix F6 to this manual "Safety Officer's responsibilities + list of Patrol materials.

F.9 Race Committee Vessels

A successful regatta requires a number of support vessels. Ensuring that these are available is sufficient a headache to warrant the appointment of a conscientious and hard working committee, knowledgeable in the characteristics of the local craft and their ownership. It may not be sufficient to know that a particular vessel is suitable and available if the owner/skipper is unsympathetic to the precision of timing and placing required in a major regatta. The selection and control of these vessels is an integral part of the on-the-water administration of the regatta. One of the Vessel Committee's principal functions after having obtained the number of vessels required, will be to roster them to their particular duties throughout the period of the regatta.

See Appendix 5 to this manual.

F.10 Social Committee

F.10.1 Social activities

Competitors will first and foremost want good racing conditions. Nevertheless they will expect and appreciate opportunities to mix socially and to enjoy themselves off the water. The programme for barbecues, receptions, formal dinners, the prize giving and any other functions should be the responsibility of a Social Committee. An attractive social programme will help to make a regatta memorable for all competitors, even those who are not among the prize winners. Always remember, however, that the social activities are complementary to the sport activities, and should be adjusted accordingly if necessary.

The Social Committee's responsibilities include the preparation of a social and entertainments programme, and if required by the Organising Authority, arrangements for Opening and Closing Ceremonies.

F.10.2 Opening Ceremony

The first formal element of the regatta may set the tone for the entire event, so planning the opening ceremony is worth careful consideration. The size and complexity of the Opening Ceremony should be left to the local organising committee. This should involve any major sponsors and the local government officials.

F.10.3 Closing Ceremony

The closing ceremony is when everybody leaves behind the tension of the competition and honours those who have won. It is also a good moment to thank all those who have worked together to make the event a success. Be careful not to make this part of the ceremony too lengthy, as it quickly becomes boring.

F.11 Press & Publicity Committee

F.11.1 General

Good publicity promotes the Class(es), the Club(s) and the sport. To be effective the organization must ensure a build-up of information through a series of releases and interviews at planned intervals. This can be quite demanding on the personnel appointed for publicity.

Establishing an internet web-site at the earliest opportunity and publicising the web address in all written material is vital to the success of any PR campaign before, during and after the regatta.

Before the regatta, advance mailings and web postings should include information about the Class(es) and profiles of their most successful competitors. Also included should be a map indicating all possible arrival routes and the Notice of Race. A few days before the regatta, signs directing competitors, press, and others to the location add efficiency, especially if there is more than one class and they are expected at different venues. Be sure to check with the local authorities for approval. Note that the posted signs should be of a size large enough to be seen at a distance of 200 m, at 80 km/hour. It helps to make them easily recognizable by the use of the Club burgee, Class emblems, event logo, etc. Use reflective paint on a contrasting background for a good visual effect during day and night, and ensure that the signs are affixed to a strong support that will withstand the weather.

At the regatta site clear identification of the individual services enhances efficiency, and is easily accomplished by labelling the various rooms/buildings occupied by the RC, Reception & Information, Protest Committee, etc. The same goes for changing rooms, first-aid post, etc. Also make use of signs saying "RC only", "results room - no entry", etc., if appropriate.

Once racing starts, regular race reports should be written and distributed, which may include descriptions of incidents, leader board changes during the race, etc., quotes from competitors and coaches, and of course, the finishing order per race as well as overall standings.

At the end of the regatta, collected press cuttings, results sheets, etc. should be readily available. Good action shots of competing sailors, in particular the leading boats, should appear on the web-site.

F.11.2 Relationship with media

It is advisable to designate a Press Secretary who should have contacts with all media. As the spokesperson for the organization his primary objective is to obtain the maximum possible dissemination of information. Functions of the Press Secretary could be:

- negotiations with T.V. stations for coverage;

- selection of a press team;
- arranging for a professional photographer;
- arranging for the making of an event video;
- producing a press brochure;
- arranging press meetings before, during and after the regatta;
- producing press releases after each race;
- producing final report after the regatta to be sent out to the media

F.11.3 Press office and facilities

The needs will be determined by the regatta size and level. For a big regatta, press facilities should include:

- Reception area attended by a Press Officer exclusively assigned to that task.
- Library area with up-to-date newspapers, magazines, brochures, regatta information, etc.
- Press room (size and equipment depending on the number of press people expected) with chairs, tables, typewriters, telex, fax, computers, e-mail/internet access, individual telephone booths, telephones, photocopiers, mailboxes, bulletin boards, photographic materials, dark room.
- Arrangements for billing telephone and fax services should also be in place.

F.11.4 Press and TV boats

- Film & photo press boat, 6-7 m long. These should be fast boats capable of more than 20 knots. They should have a semi-enclosed cabin, and room for 6 photographers (max.).
- Written press & radio boat, capable of 20+ knots, with a capacity for 10 to 15 persons. It should have a closed cabin.
- TV boat with the same characteristics as the one for the graphic press. Avoid having TV crews representing different stations on the same boat. Mix with film & photo press boat if necessary. This boat must be provided with a two-way communication system to have contact with the press room. It should be clearly marked ("PRESS-TV"). In some regattas it may be necessary to have a TV liaison person on the Race Committee boat. He will then be able to keep the TV producer informed as to the intentions of the Race Officer, start times, length of course, wind strength and direction and any other information which will enhance the TV broadcast.

F.11.5 Press accreditation

In most big sports events the use of accreditation has now expanded to identify all persons related to the organization and their access to the various areas. Accreditation is necessary when the Regatta Organising Committee wants to:

- identify everybody involved in the organization;
- control access to the various sites and limit access to certain areas by certain types of accreditation;
- facilitate services, transportation, etc.;
- differentiate privileges between different types of accreditation.

F.12 Sponsorship Committee

F.12.1 General

In days of increasing costs to organize events, yacht clubs and sailing associations are seeking outside sponsorship to assist in defraying these costs. Event sponsorship may take many forms from the donation of operating equipment, products and supplies, to the contribution of money.

F.12.2 Amount of sponsorship

There are two basic elements that a Regatta Organising Committee must evaluate when seeking sponsorship:

First, what are the needs and philosophies of the Organising Club(s)?

And secondly, what are the needs of the sponsor and what are the capabilities of the Regatta Organising Committee as far as fulfilling these needs are concerned?

Once the decision has been made to seek commercial sponsorship for an event, the Regatta Organising Committee must make a list of its requirements and the associated costs. Items on such a list may include:

- Race Management equipment (racing marks, flags, communications and electronics equipment);
- fuel for Race Committee boats;
- official publications (Notice of Race, Sailing Instructions, Race results, Official Programme);
- trophies and prizes;
- competitors souvenirs (t-shirts, caps, badges, medallions, etc.);
- Media Centre operations;
- hotels and facilities;
- food and beverages;
- computers;
- support vehicles;
- video and photographic support;
- air transportation;
- Race Officials clothing.

F.12.3 Attracting sponsors

To attract sponsors the help of a professional marketing agency may be required. Most of them will take a percentage of the sponsorship money that they acquire. To provide such a company with the necessary tools, prepare a file with the following information:

- description of the proposed regatta;
- history of the event (if not a one-off), including documentation on previous winners, press releases, etc.;
- type of organization, human and material resources involved, back-up from club, local authorities, etc.;

- detailed budget.

This same file could partially serve to request and obtain major contributions from public bodies.

F.12.4 What can you offer the sponsor?

The most valuable things you have to offer are the sponsor's name in the title of the event, and his right to direct advertising in both printed and electronic media as the "official sponsor" of the event.

Furthermore, A *RRS appendix* permits Organising Authorities to place certain event sponsored advertising on competitors' boats. However, there are many other areas where event sponsor advertising may be displayed at all times:

- There are no restrictions to event sponsor advertising on Race Committee boats, press boats or special spectator boats. This advertising may include banners, flags, decals, clothing for Race Officials.
- In any other areas on the water, including logos/names on racing marks.
- On the shore in the form of flags and banners at supporting clubs and other facilities.
- Inflatable balloons, advertising on marquees, score boards and official vehicles are options, too.
- Public announcements with audio equipment and video displays.
- All published materials including posters, Notice of Race, Official Programme, Sailing Instructions, Race Results, Press Kits, Press Releases, Club newspapers or magazines and official bulletins.
- Competitor souvenirs such as caps, T-shirts and prizes for the regatta.
- At social events: The Regatta Organizing Committee must decide to what extent and where they will permit the sponsor to have direct exposure for his name or product.

F.12.5 Contracts

Once a sponsor is obtained, a formal contract must be entered, outlining the specific requirements and responsibilities for both the Organiser and the sponsor. The contract must spell out each item in sufficient detail to avoid conflicts or misinterpretations, particularly in the area of sponsorship fulfilment. To prepare this contract, and to be properly informed about tax rules and rules for marketing, it will be necessary to have trusted legal advice.



ISAF RACE MANAGEMENT MANUAL

SECTION G

Facilities and Infrastructure

Contents		Page
G	Facilities and Infrastructure	
G 1	Race Office requirements	G 2
G 1.1	Signal mast	G 2
G 1.2	Official Notice Board	G 2
G 1.3	Public address system	G 3
G 2	Boat facilities	G 3
G 2.1	Infrastructure	G 3
G 2.2	Moorings	G 4
G 2.3	Team containers	G 4
G 2.4	Changing rooms	G 4
G 2.5	Meeting rooms	G 4
G 2.6	Communication Centre	G 5
G 2.7	Press and Media Centre	G 5
G 2.8	Drug Testing	G 5
G 3	On shore facilities	G 5
G 3.1	Boat washing	G 5
G 3.2	Parking	G 5
G 3.3	Fuel supply	G 5
G 3.4	Boat spares	G 6
G 4	Press, Media, Sponsors, VIP's	G 6
G 4.1	Press	G 6
G 4.2	Media	G 6
G 4.3	Sponsors and VIPs	G 6
G 4.4	Communications	G 7
G 5	Off-site facilities	G 7
G 5.1	Repair facilities	G 7
G 5.2	Medical facilities	G 7
G 6	Transportation and Security	G 7
G 6.1	Transportation	G 7
G 6.2	Security	G 7

This chapter specifies the necessary facilities and infrastructure at the regatta site, beginning with signal masts and boards to pass information to the competitors, mentioning boat moorings and boat storage, and ending with medical facilities, transportation and security.

G.1 Race Office requirements

G.1.1 Signal mast

The location of the signal mast should be stated in the Sailing Instructions, shall be close to the Race Office and must be visible from the competitors' boat park and from the moorings of the Committee boats. It should be high enough to be seen over the sails of the boats (8-10 m high) and have as many halyards as the number of racing areas.

Flags are hard to see when there is no wind. Recent experiments include a system of rigid flags consisting of a metallic or plastic fabric that will permit the wind to pass through. The only drawback is that it must be oriented correctly since it has only two planes of vision. An alternative would be a cylinder variation. When being hoisted, signals at the signal mast should be accompanied by a sound signal and/or a short announcement through the public address system.

G.1.2 Official Notice Board

Provide an official Notice Board with the following sections to facilitate finding the relevant information:

- Race Committee;
- Protest Committee;
- Measurement Committee;
- Results;

A second information board will serve to post:

- Meteorological information
- Social program
- Map of the facilities
- Town map indicating services as well as locations of the social events, etc.

A designated section of this board may also be used by competitors to put up their advertisements. This will preclude the posting of numerous "for sale" messages in undesired areas.

The board(s) must be adequately lit and located close to the Race Office. Its handling should be limited exclusively to Race Office personnel and the Secretary to the Protest Committee. An example is shown in the image below:



G.1.3 Public address system

The system should be able to reach all shore areas, such as boat park, moorings, measuring area, ramps, locker rooms, etc. Besides as a means to page people, it can also be used to give competitors information about the compass course and distance to the course area before going afloat.

Use of the public address system should be kept to a minimum and limited to reasonable hours. Too many unimportant messages may make listeners less attentive. Early-morning or late-night messages may cause complaints from people living close to the site.

G.2 Boat facilities

G.2.1 Infrastructure

Cranes

A crane should be available to launch and take out keelboats, coach boats, etc. The hoist should have a capacity capable of lifting the current Olympic keelboat classes. If Class Rules and Sailing Instructions allow competing boats to be taken out of the water after each racing day, it may be necessary to expand the facilities by the use of portable hoists.

The Beach Master or his delegate will be responsible for the equipment.

Dinghy park

If there is a large number of competitors, it is advisable to assign properly labelled spaces per class and/or nation, and to provide ID-tags to attach to the trolleys/trailers. This will also help the Beach Master's team to fetch and return the right equipment, when competitors sail in or out.

On locations where the winds may build up at night, it may be necessary to provide a system that will tie the dinghies to the ground, as a safety measure. This can be done with a permanent system of rings attached to the pavement. It is acceptable if there is enough space for the boats, but has the inconvenience of not being flexible for different types of dinghies. The rings should not protrude above the pavement surface, in order to avoid accidents. Another more flexible system that is able to accommodate different types of boats may be the utilization of old tyres filled with concrete and rings. Clubs may choose to have a permanent system for their own fleet and a supply of concrete-filled tyres with rings attached to accommodate different visiting classes during regattas.

G.2.2 Moorings

Competitors' boats moorings

When allowed, a large part of the fleet will avail themselves of the use of hoists for the daily launching, but Class Rules or Sailing Instructions now often require that the boats remain in the water during the competition, in which case moorings must be provided for the entire fleet.

Moorings for coach boats

Most teams have coaches who bring their own boats, usually inflatable hard-bottom dinghies. Crane or slipway facilities should be available to launch them, as well as moorings in a designated area.

Moorings for Race Committee boats

It is recommended that all the organisation's vessels be together or arranged by their specific purposes, Race Committee, Patrol, etc. This makes loading materials and victuals on board much easier. It also gives the Race Officer(s) a good overview before going afloat, and makes it easier for them to communicate with their RC team as a whole.

G.2.3 Team containers

Many teams now bring their boats in containers. These are then converted into workshops for boat repair and maintenance. Organisers are expected to provide suitable space for a number of containers.

Other teams may arrive with several boats on one trailer, including the coach boat. Space must also be found for the parking of these trailers during the event.

G.2.4 Changing rooms

Adequate changing and showering facilities should be provided for both men and women. If required additional temporary toilet facilities should be installed. Whenever there is a large number of women competitors consideration should be given to providing extra toilets.

G.2.5 Meeting rooms

Major championships require a number of meeting rooms. These are in addition to the rooms required by the Protest Committee although it is possible with careful scheduling to make these rooms available for all parties.

G.2.6 Communication Centre

This has become an essential for all major events. A minimum of six computers, linked to the internet, should be provided so that both competitors and coaches can keep in contact with their families and more importantly, their National Authorities and sponsors.

Many Race Committee and Protest Committee members are volunteers. They also require the ability to remain in contact with their families, and again, in many cases, their business. Provision of a wireless connection would enable many people to connect via their own laptop computers thus relieving pressure on the computers provided by the Organising Committee.

G.2.7 Press and Media Centre

Publicity is the life blood of any regatta. It is an essential feature of every regatta. Providing suitable facilities for the Press and the Media is therefore a high priority of the Organising Committee.

The Press have deadlines to meet for the news to be published in the latest edition of their publication.

The Media require the ability to transmit pictures, either live or recorded, to their studios. Both, therefore, require good communication links. The higher the status of the event, the more pressure there is on the Organising Authority to provide adequate facilities.

It is not possible in this manual to provide a definitive list of what is required in a good Press and Media Centre. With modern technology developing constantly, the only advice that can be given is, be aware of the latest developments and budget accordingly.

G.2.8 Drug Testing

It is a sad fact that the top athletes in many sports revert to performance enhancing drugs. For many events it is now a routine fact that drug testing will take place. Suitable facilities may need to be provided by the Organising Authority for this aspect of the regatta.

G.3 On shore facilities

G.3.1 Boat washing

If the venue is based on the sea, fresh water hoses should be provided to allow competitors to wash the salt off their boats and equipment. An adequate number of hoses should be provided depending on the number of entrants.

G.3.2 Parking

Adequate parking for cars and road trailers is essential, preferably within easy reach of the dinghy park or launching facilities.

G.3.3 Fuel supply

The quantity of fuel used in major events has increased quite dramatically. With the modern RIB and its big engines, fuel consumption has gone up. It is essential that there is adequate fuel available and that boats can be refuelled easily. In a marina or harbour this is a

relatively easy procedure. When boats are launching off a beach, then it may be necessary to make special arrangements.

G.3.4 Boat spares

A chandler should be provided at which competitors may purchase replacement equipment for their boats. Suitable arrangements should be made with a local boat yard to stock appropriate spares for the classes that are racing in the regatta. Frequently this takes the form of a contribution, in kind, to the sponsorship fund.

G.4 Press, Media, Sponsors, VIP's

This is a reminder of the importance of these people to the success of the regatta.

G.4.1 Press

The 'Front Office' will supply the Press representatives with a list of entrants and where they can be found in the venue.

A communication centre from which the Press may send their reports into their head office in time to meet the deadline of their publication, is now regarded as an essential element of any major event. Internet connection at this point is now essential.

The press, particularly photographers, will require boats from which they can operate close to the racing. It is very important that the drivers of these boats are aware of the problems they can create for the competitors by bad positioning of their boat.

G.4.2 Media

Television at a major event can take two forms. Live TV or recorded TV. The former, live TV, can create problems for race management. These can be overcome by having detailed discussions with the TV Producer on a daily basis. A TV liaison person on the main committee boat, who is in direct contact with the Race Officer, is essential.

There are fewer problems when the TV company are not broadcasting live. However, it is still advisable to communicate with the Producer on a daily basis, so that the racing programme is not disrupted.

TV will also require boats so that they can get good action shots around the course. These probably need to be of a more stable nature.

Both the Press and the Media will require access to the competitors ashore on completion of the days racing. It may be necessary for the Organising Committee to arrange for a special reserved room or enclosure.

G.4.3 Sponsors and VIPs

In many events, sponsors are the people who pay the largest part of the cost of the event. Their greatest need is exposure to the general public. This is achieved in three ways.

1. Through advertising their involvement around the venue and in the local press.
2. Through exposure on television nationally and internationally.
3. Through corporate hospitality. This will require a large comfortable craft with on board entertainment facilities.

G.4.4 Communications

Internet communication is an absolute standard in today's life. The OA must provide an easy access to Internet communications. WIFI access points are very useful to achieve this.

It is recommended to have separate access for press, race officials and competitors. This is to ensure that each of them may do their jobs without band width problems.

G.5 Off-site facilities

G.5.1 Repair facilities

These should consist of the following services:

- sailmaker;
- machine shop;
- carpenter;
- fibreglass repair shop.

Some clubs that are located close to marinas or harbours usually have this type of service available. If this is not the case, these services must be coordinated to be available, or a list must be prepared of services available elsewhere, with addresses, telephone numbers and a map of how to get there.

G.5.2 Medical facilities

Besides the medical help at sea, provision must be made to have access to full medical assistance such as the services of a local hospital, the Red Cross, a private doctor, ambulance, etc.

G.6 Transportation and Security

G.6.1 Transportation

Arrangements must be made for swift transportation of goods and people to and from the site before, during and after the regatta. An import-export agent should be contacted to coordinate and expedite temporary imports of containers, etc. Transportation needs may be needed in the following areas:

- goods (office, on-the-water, food + drink, etc.);
- competitors' boats, RC boats, trailers;
- competitors and personnel (RC, Measurement Team, Protest Committee).

G.6.2 Security

Depending on the location, it may be important to arrange security measures that will guarantee the security of competitors, personnel and materials.



ISAF RACE MANAGEMENT MANUAL

SECTION H

Vessels and Equipment

Contents		Page
H	Vessels and Equipment	
H 1	Main Race Committee boat	H 2
H 2	Mark Laying Boat	H 2
H 3	Mark boats	H 3
H 4	Pin End Start Boats	H 3
H 5	Patrol/Safety boats	H 3
H 6	Signal boat	H 3
H 7	Jury and Umpire boat(s)	H 4
H 8	Marks	H 4
H 8.1	Start Line Mark	H 5
H 8.2	Finish Line Mark	H 5
H 8.3	Other Marks	H 5

For the management of a race the Race Committee has to arrange for several vessels and boats that are suitable for the race area and adequately equipped for the tasks they are meant to perform. To have a fleet of both comfortable vessels able to carry the necessary signals and administration equipment and fast rubber inflatable boats (RIBs) to lay and move marks is desirable. Finally, the type of marks used and the quality of associated devices like lines and weights can have a major influence on competitor's satisfaction, stress on the course-setting personnel and the success of each racing day.

H.1 Main Race Committee boat

The Starting vessel should be of a size sufficient to accommodate the Race Committee personnel in reasonable comfort. Depending on the type of course, it may also act as Finishing vessel. It should be appropriate for the conditions likely to prevail in the course area; it should be manoeuvrable, visible and clearly identified in accordance with the Sailing Instructions.

A full set of signal flags as used in the RRS Race Signals and the Sailing Instructions Guide, should be carried and attached to the halyards as shown. The mast which is often used as the RC Boat end of the start line should be tall and clearly visible.

Layout of Flags and Halyards

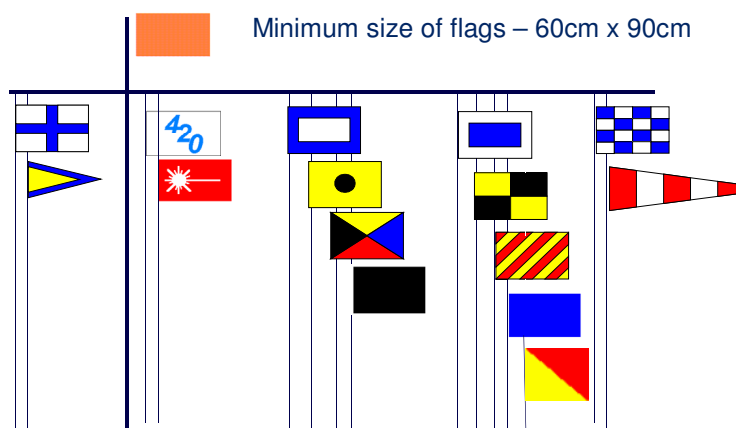

This boat should also have adequate cover against too much sun, wind, rain or other inclement weather. It should also carry Radio, GPS, charts of the race area plus any other navigational aids that could be useful. Toilet facilities should also be available.

H.2 Mark Laying Boat

The Mark Laying boat should be a fast power boat equipped with instruments for determining either speed or distance run, or both, as well as a reliable compass and GPS. Many Race Officers prefer more than one Mark Laying boat. This facilitates the fast adjustment of the course to a new wind. Should the equipment and personnel be available, one mark boat per mark is desirable.

Between starting and finishing, the Mark Laying boat may be used as a safety boat although its main task is to stand by for alterations to the course in the event of a wind change. This vessel, like the Mark boats, is a source of information to the Race Officer.

This boat will carry the marks it is required to lay, together with spare marks, counter weights, ropes and anchors.

It should be manned by a crew with competent seamanship skills.

H.3 Mark boats

Mark boats are desirable for major regattas in open waters, especially when the legs are longer than 1 NM or when visibility is hampered by large waves or poor conditions. They can contribute to the fairness of the racing. Mark boats are ideally keelboats or any kind of displacement vessel with a tall mast. Mark boats should be adequate for the conditions that are likely to apply in the area. While on station, Mark boats record mark roundings, which may be of use to the Race Committee or the Protest Committee afterwards. Mark boats can also be used for mark laying or shifting marks following a course change, in which case they may need additional equipment. One mark boat per mark is required at major events.

Both Mark Laying boats and Mark boats should be equipped with visual and sound signals. The flags to be carried should include course change signals, abandon and, if appropriate for the event, the rule 42 'switch off/switch on' signals

H.4 Pin End Start Boats

It is preferable to have a RIB boat with a tall mast as the Pin End Starting Mark every time. This will make the job of the Assistant Race Officer, sighting the line from that end, easier. It also means that the start line can be adjusted from either end by paying out additional line.

H.5 Patrol/Safety boats

Patrol boats should be of adequate capability to assist boats in distress under adverse conditions. An adequate number of patrol craft should be provided. Each craft should be manned by at least two competent persons.

Depending on the racing environment, Patrol boats should carry thermal blankets, water, sunscreen, seasick tablets knife and wire-cutters.

All Race committee boats used for major events (signal, pin, finish and mark boats) should be equipped with a GPS. All GPS units should be set up to display as follows:

- Distance in Nautical Miles (nm)
- Time to local time zone in 24 hour format
- Compass bearing in magnetic
- Latitude and Longitude in decimal minutes (example: 39 27.928 North, 034 17.464 East)
- Map Datum WGS 84

H.6 Signal boat

For very large fleets consideration should be given to using a Signal boat to be stationed on the course side and approximately in the middle of the starting line, and around 100 to 200 metres to windward. All the race signals start visuals and sounds will be made from this boat.

H.7 Jury and Umpire boat(s)

In many major regattas with fleet racing, judging on the water of illegal methods of propulsion, is now a normal practice. A necessary requirement is the provision of suitable craft by the Organising Authority. The Rigid Inflatable Boat (RIB) is considered ideal.

Boats have to be highly manoeuvrable, with shade against the sun, dry if possible and capable of staying at sea for long periods. They should be capable of carrying a minimum of two judges but ideally three.

In nearly all match and team racing on-the-water umpires are used to signal infringements and instant penalties. Major international championships usually have an International Jury which may take some responsibility for observing infringements and even lodging protests, especially relating to contact between boats, illegal propulsion, touching of marks, etc.

In this case a number of Jury boats may be required, dependent on the number of Jury members who are supposed to be 'on the water' during racing.

Jury vessels should always be identified by a Jury flag, which may be the letter "J" or the word "Jury" on a contrasting background.

H.8 Marks

Course Marks should be highly visible against sea or land (bright yellow or rescue orange) and easily towed and handled by the Mark Laying boat. If marks not in use are towed during a race, the Mark Laying crew must ensure that competitors do not get confused by moved marks. The most suitable types are inflatable neoprene cylinders or spheres of a size suitable for the length of course and height of waves. Cylinders of 1.2-1.5 m height and spheres of about 1m diameter are suitable for most small-boat classes.

Marks used for a change of course should be of a different shape or colour or have some distinguishing mark such as a coloured (or black) band or sleeve which can be slipped over the mark.

Cylindrical marks need a counter-weight to keep them upright. Old anchor chain is the best for this task. All anchor lines need a counter-weight fixed to the anchor line about 2-3 metres below the surface to keep the line down and away from close rounding boats. Many venues now use better designed shapes that do not require counter-weights. These include cylindrical dumpy buoys, and tetrahedrons.

The type of anchor best suited to the locality should be determined. Generally some form of wide fluked grapnel anchor is most satisfactory. Dan forth anchors are easily fouled and when well bedded are sometimes difficult to retrieve. The line should be long enough to prevent the mark dragging in heavy weather but not so long that the mark shifts with variations in wind and tide. Preferably some chain should be used at the anchor end to prevent chafing and improve holding. In very deep water, marks can be secured with disposable ground tackle consisting of reject or damaged concrete blocks and non-synthetic (bio-degradable) twine which can simply be cut.

Because the marks sometimes have to be retrieved in very adverse conditions, a small buoy is attached to the counter-weight so that it just reaches the surface. Small buoy, counter-weight and mark are then retrieved in that order and the biodegradable anchor line twine is cut below the leader.

H.8.1 Start Line Mark

At major events, the Pin End Starting Mark should be an anchored boat, not a mark.

It is preferable to have a boat with a tall mast as the Pin End Starting Mark every time. This will make the job of the Assistant Race Officer, sighting the line from that end, easier. It also means that the start line can be adjusted from either end by paying out additional line.

In some regattas a dan buoy is used for the Pin End Starting Mark. Once this is laid it is difficult for the Race Officer to 'fine tune' the start line, as the adjustment can only be made at the Committee Boat end.

H.8.2 Finish Line Mark

This is normally a dan buoy. It is not normal to have another boat in this position, but should one be available then it can be used in place of the dan buoy.

H.8.3 Other Marks

At some major championships, coach boats, spectator boats, etc. are restricted to an area where they cannot influence the race. This area is frequently delineated by small buoys which cannot be confused with the three sets of marks above.



ISAF RACE MANAGEMENT MANUAL

SECTION I

Race Documents

Contents	Page
I Race Documents	
I 1 The Notice of Race	I 2
I 2 The Sailing Instructions	I 2
I 3 ISAF Regulations	I 3
I 4 National authority prescriptions	I 4
I 5 Class Rules	I 4
I 6 Any other documents that govern the event	I 4

This chapter deals with the Notice of Race and the Sailing Instructions, two important race documents. The Notice of Race can be seen as a formal offer to a potential competitor. It has to be drafted with great accuracy as it specifies the conditions for entry, the classes and the rules to govern the event. The Sailing Instructions are most important to the success of a regatta, as they provide additional information to the competitors and may change some Racing Rules that shall apply to the event.

But there are more documents applying at a regatta: ISAF regulations; National authority prescriptions; Class Rules.

I.1 The Notice of Race

The Notice of Race is published by the Organising Authority and should conform to RRS Appendix J1.

In legal terms, it is a formal offer of contract to a potential competitor with the conditions under which he or she will be allowed to participate in the regatta. If the competitor enters the regatta on the basis of the Notice of Race, he must be assured that the event will be held at the time and place and for the class(es) specified. He must also be assured that participating in this regatta will not bring him in conflict with the ISAF eligibility rule.

Drafting the Notice of Race is a job that must be done with great accuracy. Appendix J1 lists five items that should appear in the Notice of Race and a further fourteen which should be included if it will help the competitor to decide to enter.

Appendix K is the 'Notice of Race Guide'. This Guide should be the basis of every Notice of Race. Using it has two advantages:

- The words used are those approved by the ISAF RRC. This provides a standard terminology.
- The Guide provides alternatives, that is, a 'pick and mix' system with marginal notes. This enables the Organising Authority to tailor the Notice of race to their particular event.

The start time in the Notice of Race, should be set, based upon prevailing conditions. For example, the start should not be scheduled at 10.00 hrs, if the sea breeze never comes in until 13.00 hrs.

Because the Notice of Race is now a rule (see the Definitions in the RRS), it should not contain information about accommodation, the social programme, car parking, etc. However, as this information is vital to competitors entering the regatta it should be published in a separate document (or in a clearly separate section at the end of the Notice of Race, under the heading "additional information")

I.2 The Sailing Instructions

The Sailing Instructions are published by the Race Committee and should conform to RRS Appendix J2.

When writing the Sailing Instructions, reference to the Notice of Race, should be made, avoiding any repetition of its content. This will ensure that statements made in the Notice of Race are compatible with the Sailing Instructions.

Particular attention should be made not to repeat in the Sailing Instructions any racing rule, ISAF regulation or Notice of Race rule. Repetition will immediately bring confusion about the application of the non repeated rules.

Even worst practice is to include statements in the Sailing instructions with the same intention as the rules but different wording.

The Sailing Instructions are extremely important and must be prepared with great care. The effective operation of the regatta, the responsibility and authority of the officials and the all important link to the Racing Rules and, if appropriate, the Appeal Authority, are governed by these instructions. It is equally important that the Race Officer and all the officials associated with the actual conduct of the regatta be thoroughly conversant with them.

RRS Appendix J2 lists the nine items that all sailing Instructions must contain. There are a further 38 items which may apply depending on the size, status and class or classes involved in the regatta.

RRS Appendix L is the 'Sailing Instructions Guide'. This Guide should be the basis of all Sailing Instructions. Using it has three advantages:

- The words used are those approved by the ISAF RRC and are consistent with the Racing Rules terminology. This provides a standard terminology.
- The Guide provides alternatives, that is, a 'pick and mix' system with marginal notes. This enables the Race Committee to tailor the Sailing Instructions to their particular event.
- The Guide proposes instructions that been carefully considered and tested for many years, being the result of an experts work.

For the top level regattas, there is an Appendix LE. This is an expanded version of Appendix L containing provisions to even the largest and most complicated multi-class events, and variations of the sailing instructions found in Appendix L. This version includes sailing instructions for The Medal Race Concept.

The Standard Instructions should be used unless there is good reason for deviating from them. Local harbour by-laws may have to be considered, or special launching and retrieving requirements. Class Rules may prescribe some aspects of the regatta. The use of standard Sailing Instructions is a valuable service to competitors worldwide, who should not be confused by each Race Committee confronting them with its own version.

Once the first draft have been agreed a copy should be sent to the Chairman of the Jury or Protest Committee, for comment. Because this document describes the method of working of the Race Committee, it is essential that when the Jury check the document they check the language and its interpretation only and do not alter the method of working.

The updated version of all mentioned documents may be downloaded from the ISAF website (www.sailing.org/raceofficials/eventorganizers/nor.php) as well as the current version of Addendum Q, an Addendum to Sailing Instructions for Umpired Fleet Racing and, in particular, for a Medal Race

I.3 ISAF Regulations

The rules related to eligibility, advertising, anti-doping and sailors' classification are not anymore included in the rules book but incorporated into regulations approved by ISAF that can be modified at any time. Nevertheless they rank as rules according to the definition.

Those rules are.

- Eligibility Code (regulation 19)
- Advertising Code (regulation 20)
- Anti-Doping Code (regulation 21)
- ISAF Sailor Classification Code (regulation 22)

The first three are always mandatory, whilst the classification code only applies when specifically called in the Notice of Race (unless already stated in the Class Rules).

I.4 National authority prescriptions

Because a National authority prescription may change a rule (to the extent permitted by rule 86) it is very important to make clear in the Notice of Race whether or not a prescription apply. Rules J1 and J2 require to include both in the Notice of Race and the Sailing Instructions.

A copy of the prescriptions in English language shall be included in the Sailing Instructions.

I.5 Class Rules

The Class Rules define the characteristics a boat and its equipment has to have to be considered as such. Compliance with the rules is essential to guarantee the homogeneity amongst boats ensuring a fair racing.

But the Class Rules is also the document where the conditions for racing a particular boat are defined: for example, how many sailors should be on board, how many sails a boat may carry while racing, etc.

Both aspects (as well as other administrative rules to administer the class) are considered Class Rules and, for ISAF International and Recognised classes, need to be approved by ISAF prior to come into force.

However, the 'conditions for organizing championships' do not belong to the Class Rules and to have it applicable need to be specifically mentioned in the Notice of Race and the Sailing Instructions.

I.6 Any other documents that govern the event

There could be other regulations or documents containing rules that should apply at the event. Rule J2.1(a) mentions The Equipment Rules of Sailing, as an example). But could be other, for example the Class 'conditions for organizing championships'.

In any case all other documents need to be included in the Notice of Race and the Sailing Instructions to come into force.



ISAF RACE MANAGEMENT MANUAL

SECTION J

Competition Formats, Course and Race Areas Selection

Contents		Page
J	Competition Formats, Course and Race Area Selection	
J 1	Competition formats	J 2
J 1.1	Match Racing	J 2
J 1.2	Team Racing	J 2
J 1.3	Fleet racing	J 2
J 2	Course Selection	J 4
J 2.1	Course geometry	J 4
J 2.2	Tips to select the Course	J 5
J 2.3	Gates	J 5
J 2.4	Off-set mark	J 6
J 3	Course types	J 6
J 3.1	Triangle and Windward-Leeward Course	J 6
J 3.2	Windward-Leeward Course	J 7
J 3.3	Trapezoid Course – Inner and Outer loops	J 8
J 3.4	The offset mark	J 9
J 3.5	The Slalom	J 9
J 4	Describing the course in the sailing instructions	J 10
J 5	Selection of the race area(s)	J 10

Different competition formats are briefly outlined. Fleet racing, handicap racing, team racing and match racing are frequently used. Then, the most common courses, with their description, particularities and advantages.

Finally, some aspects of how to select the race area(s) are mentioned, e.g. class championship rules, possible length of legs, distance to shore, maritime routes and fishing areas, usual wind conditions, water depth and overlap with other race areas.

J.1 Competition formats

Sailboat racing may be run in different competition formats. Some events have been specially created to make use of the new competition formats, for example events for match racing. The most frequently used formats are:

J.1.1. Match Racing

Matches are short races performed by just two competing boats of the same class/design. All competitors may meet each other in one or more matches, competing in a Round-Robin series, or sailing against only some other competitors in a knock-out series. Scoring is based on the number of wins in the matches sailed. Matches are usually umpired and penalties given on the water with a number of particular match racing rules (see RRS C) applying.

J.1.2. Team Racing

Two teams, each consisting of several boats, compete in "fleet" races or match races against each other. Special rules (see RRS D) apply. Results for each team are summed by the results of each team member boat.

J.1.3. Fleet racing

Most frequent and "classic" way of competition in sailboat racing: there are several different formats of fleet racing. They are:

Handicap Racing

Boats of different classes race together one or more races on the same course using one or several different handicapping systems. This format is very common in offshore racing, but also for small cruiser boats. They may or may not start at the same time for each race. The elapsed time (how long it has taken the boat to complete the full course) is adjusted using one of the handicapping formulas, to provide a 'corrected time'. The boat with the fastest 'corrected time' is the winner. IRC, ORC International & ORC Club are some of the most common formulas in international racing, but there are many other used national or locally worldwide.

One-design racing (class racing)

All boats of the same class race together, starting for each race at the same time and sailing on the same course. Scoring follows the principle: the better a boat's finishing places, the better her overall results (see RRS A). The fleet can be unlimited in size, which can lead to very long start lines. Is the common format for dinghies and small multihull classes.

Sailing divided into Groups

Facing many entries in some major events, regatta organizers may choose "sailing into groups" as an alternative to large fleets crowding at the starting line and at each mark.

Another reason to choose this format is because the actual preferences to sail short races and as many as possible: in that case is very hard for large fleets to provide equal opportunities to finish in the top of the fleet.

The fleet is split into (e.g. four) groups of nearly the same size and ability; to achieve that, competitors are seeded into each group by their recent performance (ISAF, National or Class ranking list position) and / or by casting lots. In certain events national/geographic aspects are also considered when, for example, the seeding produces too many competitors from the same country or continent in the same group.

Each group is scored separately, their scores merged to produce an overall position. The competitors will be regrouped after a pre-determined number of races completed (usually after each racing day) and according to their overall score up to that moment.

In some events, the fleet race in that format the whole regatta and this is when the leader is declared; but more often, the fleet race a “qualification series” according to the explained format, and when all groups reach a number of races new ‘Gold, Silver, Bronze and maybe Emerald’ groups are created for a final series. The composition of those new groups do not change anymore, thus sailors race in the same gold, silver, etc, groups for the remaining of the event.

Scoring follows the same principle as per class racing (the difference being the number of “entrants” for scoring purposes equals the number of participants for the largest fleet and not the total of regatta entrants), all the scores count towards the final results (except the discarded scores, when stated in sailing instructions).

An alternative to the above system is when competitors are split into groups and remain in the same group for the whole regatta. Then each group race against each other group in fleet races at least once, i.e. in a kind of “round robin” of groups. While this variation ensures that each competitor has raced against every other entered competitor it is not flexible because to keep that principle once, every time a new “round robin” is started, it should be finished. Technically is possible to stop racing at any moment, not having completed the second or any subsequent round, provided that all groups have the same number of races, i. e. all competitors have the same number of scores, but then the principle is broken.

A regatta with split fleets involves a lot of additional administration efforts. Boats have to be identified by, for example, coloured ribbons, indicating their current group membership. Distribution, exchange and return of ribbons have to be managed, as well as calculating the results at the end of each racing day and determining new groups for the next racing day during the qualification series as well as to determine the Gold, Silver, etc, groups for the final series.

The Medal Race

A new competition format known as the ‘Medal Race’ has been adopted for the Olympic regatta and is also used at all major events for Olympic classes. Each class (event in the Olympic terminology) sails an “opening series” as explained above (either a single series or a qualification series followed by a final series) and then a medal race.

The medal race is a step forward in the direction of the idea that the winner of that race is the winner of the event. Only the top ten classified at the end of the opening series may enter the medal race but their participation is compulsory. The medal race cannot be dropped from the final score, i.e. cannot be discarded, and it is scored double points. And to

enhance the idea of the arrival order is the official classification for that race, on the water judging shall apply.

The use of the medal race requires a specific set of sailing instructions dealing with all its peculiarities. They are actually included in Addendum C to RRS Appendix LE –Expanded Sailing Instructions Guide- and Addendum Q –Umpired fleet racing- (whose up-to-date versions may be downloaded from the ISAF website). Addendum Q preamble reads:

“Under rule 86.2 and Regulation 31.1.3, the ISAF has approved the use of Addendum Q to the sailing instructions in World Championship Grade, Grade 1 and Grade C1 events, for umpired fleet racing in the last race of each series for the Olympic classes. Similar events are also encouraged to use the addendum. This can be done under rule 8J.3 if the national authority prescribes that rule changes are allowed for the purpose of development and testing.

Races may be sailed under the sailing instructions in this addendum only if the notice of race so states and the addendum is included in the sailing instructions.

Use of this addendum is recommended for races in which about ten one-design boats compete with umpires present. There should be one umpire boat for every three or four boats in the fleet.”

J.2 Course Selection

J.2.1. Course geometry

In the past courses usually provide a combination of beating, reaching and running –each leg testing particular tactical and boat handling skills. Recent developments have shown a preference by many classes, for windward-leeward courses removing the long reaching legs where passing opportunities are difficult to find. Exceptions are long-distance point-to-point races, where often changes in weather provide the variations desired.

Some courses have no regular geometry. Race Committees often use harbour beacons and other permanent marks as a convenience and some races use geographical features such as islands. This is very common in offshore sailing (refer to Offshore racing section for more details)

Before deciding on the course geometry, the Race Officer and the Race Committee should liaise very closely with the Class Association. The officials of the Class will be more familiar with the characteristics of the boat and what type of course geometry is most suitable for their event.

Note that many Class Associations have championship rules that apply to their official championships. Their courses are usually defined and the Race Committee is not entitled to change it, except in special circumstances and always in agreement with the class representative. The same principle applies to ISAF for their own events and major regattas, as well as for the official championships of continental and national federations.

However, the essential is the concept behind the chosen course(s) by the class. Often local conditions can have an adverse effect on the efficient running of the event, and a change of course is

A good Race Officer will not impose his will on the class but should be able to advise them of the affect course selection will have on the efficient race management of the event.

Knowledge of local conditions which can have an adverse effect on the efficient running of the event should be brought to the attention of the class association at an early stage of the planning.

J.2.2. Tips to select the Course

The selection of the type of course to be used for a regatta, and indeed for a particular race within a series, will depend upon such factors as:

- the type and speed of the competing boats around the course
- the format and the number of entered boats;
- the number of classes / groups to race in the course

The Class Association rules governing their official championships, ISAF and continental and national federations may describe the configuration desired although the Sailing Instructions can always override such a description.

Whatever the course configuration, convention and common sense should play a part in the course selection.

Courses should be consistent and not complicated. Even for a course around harbour marks, all mark roundings, where the rounding could be either way, should be consistently port or starboard. Having some marks to be left to port and other(s) to starboard often leads to confusion.

Port-hand roundings are often preferred at a windward mark, because racing rules favour boats approaching the mark on starboard tack, thus contributing to a smooth rounding and rule 18 compliance. Therefore, for major events, where there are no geographical constraints, a port hand course is always used. An exception to this is match racing or team racing, where starboard roundings are widely used: at the windward mark it gives a better chance for a port tack boat to pass the mark. Note that these are disciplines with 2 or very few competing boats. In a large fleet, the tactical advantages of starboard roundings disappear and may cause more confusion than port roundings.

Looping around marks should be avoided, because, especially at downwind marks, the boats that are rounding are blanketed by the approaching boats (to windward of them), have no speed to complete the rounding and a critical bunch of collisions and frustration may easily come. In addition, in a looping mark, racing rules are very difficult to comply with, rule 18 switching on and off for different boats approaching and leaving the same mark: competitors have a big difficulty to realise which rule is in force and who is the right of way boat and their capacity to react and change course is very limited. As a result, rules compliance is seriously threatened.

On a beat a fleet tends to spread out –the leading boats have clear air and less interference from other boats. On a run the leading boats may be blanketed and the fleet closes up. Because of this and because an upwind start is the fairest, a race should start with a beat or have a beating leg as soon as possible after the start.

J.2.3. Gates

A gate is usually set at the leeward mark. It gives the skipper wishing to move to the port wing of the course on the beat, the opportunity to round a mark of the gate to starboard and thus avoid having to cross the fleet sailing downwind

The length of the gate will depend on the size of the fleet, the speed of the boats, the sea conditions and the depth of water and bottom type.

The minimum length should be seven boat lengths, thus allowing a boat length between the three boat length circles round each mark. It is normal practice to make the gate between 9 and 10 boat lengths in width. The maximum recommended is ten boat lengths.

The following table shows an average gate length taking account only of the boat length zone size:

Boat length zone	Min	Max
3 (default)	7	9 - 10
2	5	7 - 8
4	9	11 - 12

RRS 86.1(b) permit the Sailing Instructions to change to “two” or “four” the number of hull lengths determining the zone around the marks, provided that the number is the same for all marks and all boats using those marks. If this is the case, the above figures related to minimum, maximum and recommended distances between marks should be changed accordingly.

J.2.4. Off-set mark

This is the term applied to a mark which is set some 50 to 100 metres on the port side of mark 1 (or, for starboard roundings, on its starboard side). It is designed to take the fleet away from mark 1 before the boats set off on the run and hoist spinnakers, if any. Its location in terms of distance and angle from mark 1 are very type of boat specific and the advice of the class association should be sought at an early stage of the planning process.

J.3 Course types

Although there are a number of possibilities to design a course, the following will focus on the basic types used in fleet racing.

J.3.1. Triangle and Windward-Leeward Course

This was always known as the ‘Olympic’ course. This is no longer the case. The triangle and windward-leeward, as it was known, is not used in the Olympics because in the context of that Regatta it is no longer an efficient use of resources and time.

However, when there is a one class Championship, and the class require reaching legs, then this should be the preferred course. It has the advantage that when mark 2 is positioned correctly it can give a variety of reaching angles. Some classes prefer an equilateral triangle, giving 60° at all marks. Other classes prefer a slightly broader reach and so they have 45° between marks 1 and 2 and 90° at mark 2. Finally, there are those classes who would like a close reaching leg

Windward-Leeward-Triangle

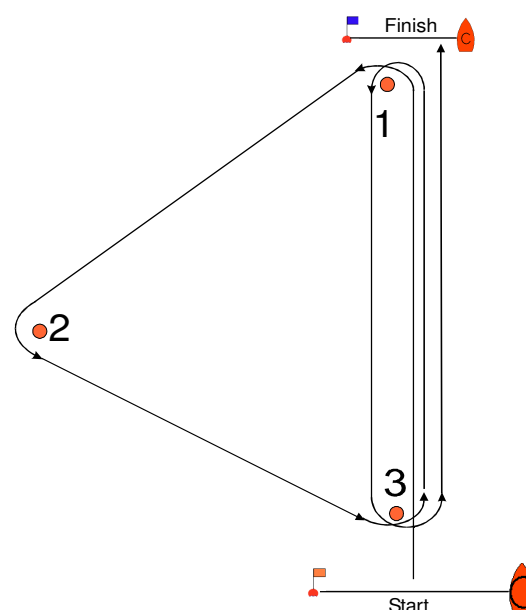

and a broad reaching leg. This is best achieved by having 70° at mark 1, thus giving a close reach from mark 1 to mark 2 and a broad reach between marks 2 and 3.

The windward-leeward leg covers the other two aspects of racing, the beat to windward and the downwind run.

Position of the start and finish lines

The drawing shows a separate start and finishing lines. Its advantage is that provides the flexibility of making starts when other class / group is rounding mark 3 or to separate boats going to the finish from others still rounding the windward mark.

The most usual position for the start line is immediately downwind of mark 3. Some 50 metres is sufficient distance.

If the race area is restricted, some race committees have set the start line upwind of mark 3. Care should be taken when doing this that there is sufficient distance between the start line and mark 1 to allow the fleet to spread out before reaching mark 1.

The traditional place for the finish line in this course is approximately 50 metres upwind of mark 1. This allows the fleet to finish on a windward leg and usually makes for easier recording of finishing places on the Committee Boat. However, this is not the best place if more than one race per day is to be sailed back-to-back: it creates a delay while the fleet returns to the starting area. Or, in the last race of the day or in particular wether conditions, to keep finishers close to the race committee boat or to the shore.

To overcome this, the start line is reduced in length, and becomes the finishing line. Care has to be taken when recording boats at the finish as sometimes their numbers can be obscured as they cross the finish line.

J.3.2. Windward-Leeward Course

This is the simplest of courses to set. If there is a large fleet, then an additional mark is required, so that mark 2 can become a gate.

Windward-Leeward

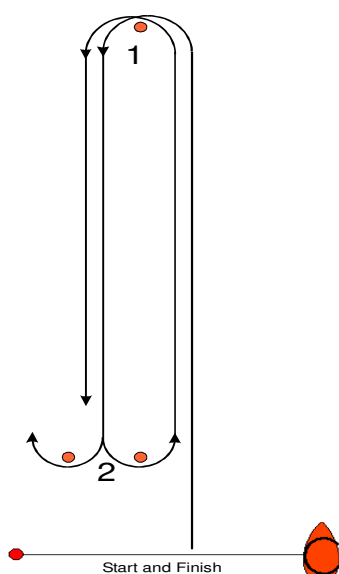

A gate is recommended in this course because after the fleet have spread out on the beat, the back of the fleet will start to catch the leaders on the run. A gate gives competitors the opportunity to choose which side of the next beat to use without having to cross boats running downwind with spinnakers.

Position of the start and finish lines

The most usual position for the start line is immediately downwind of mark 2. Some 50 metres is sufficient distance.

Because the windward-leeward course is frequently used when more than one race per day is to be sailed and there is no scheduled start time for race 2 and subsequent races, the start line (reduced in length) becomes the finish line.

Some classes vary this by moving the finish line 50 metres upwind of mark 1 for the last race of the day.

J.3.3. Trapezoid Course – Inner and Outer loops

Trapezoid Inner & Outer Loops

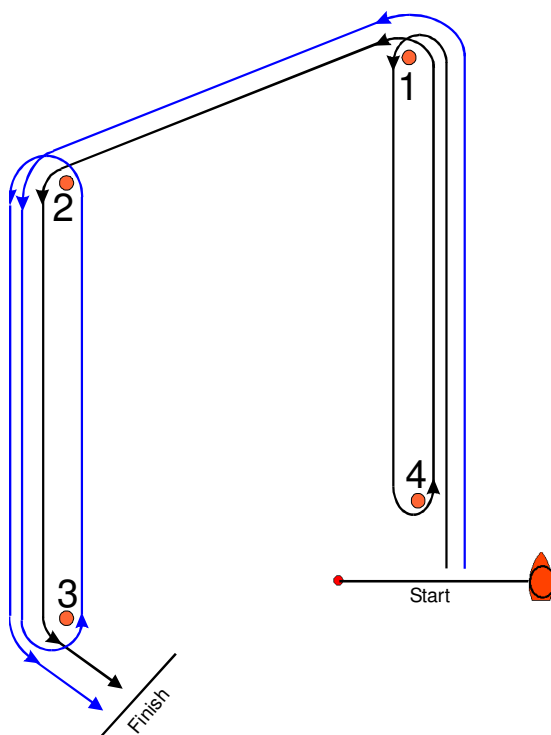

Because the Trapezoid course has been used in the last few Olympic Regattas, it has been given the title of the 'Olympic' course. This is not correct.

The trapezoid is two windward-leeward courses parallel to each other and is designed to accommodate two different classes or two flights of the same class, on the same course area and using the same start and finish lines. The reaching leg between marks 1 and 2 is there as a 'spacer' between the Inner and Outer Loops. The length of the reaching leg between marks 1 and 2 should be approximately two-thirds of the length of leg 1.

The trapezoid requires a greater area of water than the other courses.

It is the most difficult course to set and the most difficult course to adjust to a new wind after the race has started.

The course length is to be set to give the first boat of each fleet the best chance of achieving the target time. Getting the course length correct, particularly when there are two classes with different boat speeds, is essential, otherwise a faster class can quite easily catch up the slower class.

Another peculiarity of this type of course is that there are times when the wind on the inner loop and the wind on the outer loop can vary in strength and direction. This could be considered a disadvantage, however if we think at the trapeze as two parallel windward-leeward courses, then this type of course give the race committee a lot of flexibility to set up the course for different groups.

If resources allow, it is better to have two course areas and race committees sailing windward-leeward courses than one race committee with two classes sailing a trapezoid.

Gates

These are usual at marks 3 and 4. Mark 4p/4s shall be laid after the start (second start in case of multiple fleets) and not in case of the medal race, if sailed.

Position of the start and finish lines

The most usual position for the start line is immediately downwind of mark 4. Some 50 metres is sufficient distance.

The finishing line is set on a reach from mark 3 to the finish.

J.3.4. The offset mark

A variation to the above courses consists in adding an extra mark close to the windward mark, usually called ‘offset mark’. Its purpose is to impeach boats rounding the windward mark to immediately initiate the downwind leg, therefore potentially interfering with boats still beating to reach the windward mark.

J.3.5. The Slalom

This is the latest configuration used for Olympic boardsailing. It is composed of a trapezoid course (inner and outer) or a windward-leeward course followed by a three buoy slalom before reaching the finish.

IS

Course: Inner Slalom

Signal	Marking Rounding Order
IS2	Start - 1 - 4s/4p - 1 - 2 - 3p - S1 - S2
	- S3 - Finish
IS3	Start - 1 - 4s/4p - 1 - 4s/4p - 1 - 2
	- 3p - S1 - S2 - S3 - Finish
IS4	Start - 1 - 4s/4p - 1 - 4s/4p - 1 - 4s/4p
	- 1 - 2 - 3p - S1 - S2 - S3 - Finish

OS

Course: Outer Slalom

Signal	Marking Rounding Order
OS2	Start - 1 - 2 - 3s/3p - 2 - 3p - S1 - S2
	- S3 - Finish
OS3	Start - 1 - 2 - 3s/3p - 2 - 3s/3p - 2 - 3p - S1
	- S2 - S3 - Finish
OS4	Start - 1 - 2 - 3s/3p - 2 - 3s/3p - 2 - 3s/3p
	- 2 - 3p - S1 - S2 - S3 - Finish

LS

Course: Windward/Leeward With Slalom Finish

Signal	Marking Rounding Order
LS2	Start - 1 - 4s/4p - 1 - 4p - S1 - S2 - S3
	- Finish
LS3	Start - 1 - 4s/4p - 1 - 4s/4p - 1 - 4p
	- S1 - S2 - S3 - Finish
LS4	Start - 1 - 4s/4p - 1 - 4s/4p - 1 - 4s/4p
	- 1 - 4p - S1 - S2 - S3 - Finish

J.4 Describing the course in the sailing instructions

The description the courses(s) to be sailed is one of the contents that must be included in the SIs (see Appendix J2.1).

It is of the highest importance to describe courses in the same way all around the world to avoid confusions.

L1	Start – 1 – Finish
L2	Start – 1 – 4s/4p – 1 – Finish
L3	Start – 1 – 4s/4p – 1 – 4s/4p – 1 – Finish
L4	Start – 1 – 4s/4p – 1 – 4s/4p – 1 – 4s/4p – 1 – Finish
LA1	Start – 1 – 1a – Finish
LA2	Start – 1 – 1a – 4s/4p – 1 – 1a – Finish
LA3	Start – 1 – 1a – 4s/4p – 1 – 1a – 4s/4p – 1 – 1a – Finish
LA4	Start – 1 – 1a – 4s/4p – 1 – 1a – 4s/4p – 1 – 1a – 4s/4p – 1 – 1a – Finish
I2	Start – 1 – 4s/4p – 1 – 2 – 3p – Finish
I3	Start – 1 – 4s/4p – 1 – 4 s/4p – 1 – 2 – 3p – Finish
I4	Start – 1 – 4s/4p – 1 – 4 s/4p – 1 – 4 s/4p – 1 – 2 – 3p – Finish
IA2	Start – 1 – 1a – 4s/4p – 1 – 1a – 2 – 3p – Finish
IA3	Start – 1 – 1a – 4s/4p – 1 – 1a – 4 s/4p – 1 – 1a – 2 – 3p – Finish
IA4	Start – 1 – 1a – 4s/4p – 1 – 1a – 4 s/4p – 1 – 1a – 4 s/4p – 1 – 1a – 2 – 3p – Finish
O2	Start – 1 – 2 – 3s/3p – 2 – 3p – Finish
O3	Start – 1 – 2 – 3s/3p – 2 – 3s/3p – 2 – 3p – Finish
O4	Start – 1 – 2 – 3s/3p – 2 – 3s/3p – 2 – 3s/3p – 2 – 3p – Finish
IS2	Start – 1 – 4s/4p – 1 – 2 – 3p – S1 – S2 – S3 – Finish
IS3	Start – 1 – 4s/4p – 1 – 4s/4p – 1 – 2 – 3p – S1 – S2 – S3 – Finish
IS4	Start – 1 – 4s/4p – 1 – 4s/4p – 1 – 2 – 3p – S1 – S2 – S3 – Finish
OS2	Start – 1 – 2 – 3s/3p – 2 – 3p – S1 – S2 – S3 – Finish
OS3	Start – 1 – 2 – 3s/3p – 2 – 3s/3p – 2 – 3p – S1 – S2 – S3 – Finish
OS4	Start – 1 – 2 – 3s/3p – 2 – 3s/3p – 2 – 3s/3p – 2 – 3p – S1 – S2 – S3 – Finish
LS2	Start – 1 – 4s/4p – 1 – 4p – S1 – S2 – S3 – Finish
LS3	Start – 1 – 4s/4p – 1 – 4s/4p – 1 – 4p – S1 – S2 – S3 – Finish
LS4	Start – 1 – 4s/4p – 1 – 4s/4p – 1 – 4s/4p – 1 – 4p – S1 – S2 – S3 – Finish

The table shows the current text included in all top events. The letter indicates the type of course (L for windward/leeward; LA, idem with an offset mark; I for trapeze inner loop; IA, idem with an offset mark; O for trapeze outer loop; OA, idem with an offset mark; IS for slalom with trapezoid inner loop; OS for slalom with trapezoid outer loop; LS for slalom with windward/leeward). The figure next to the letter indicates the number of laps to complete.

J.5 Selection of the race area(s)

The selection of the race area and the number of them is an option directly related to:

- the area of water available;
- the anticipated wind strength;
- the number and type of different competing classes;
- the format of racing and the number of entered boats;

Using a trapezoid course allows a maximum of four starting groups / classes in order to provide several (usually two or three) races per day with quality and comfort. A big number of groups may compromise the ability of starting the second and subsequent races for the groups / classes already finished. In other words, splitting a class into groups could imply the need to have more than one racing area.

The type of competing boats will influence clearly the number of racing areas. Type of course and leg distances are different for many types of boats and it is very unlikely to find a compromise to have all them in the same racing area. Boat speed and downwind angles are also very different for particular type of boats (boards, skiffs, multihulls...) and having them sailing in the same racing area together with dinghies or keelboats may be risky.

Whatever the number of racing areas is used, the Race Committee needs to establish its location well in advance. If several areas will be in use at the same time, it is vital that they do not overlap, not even if one Race Committee starts shifting its marks before the other one(s) do(es).

An excellent way to visualize the location of one or more regatta areas over the chart is to cut out cardboard or draw on transparent plastic the circles for each area, then to move them over the chart so as to easily see all the possible features of the general area until the most adequate location is found.

To ensure that the Race Committees always know exactly where they are, and are thus able to stay well clear of each other's area, provide them with a list of coordinates of eight points on their race circle (N, NE, E, SE, S, SW, W, NW), and the coordinates of the centre of the circle.

If certain Class Championship Rules apply, they should be checked for requirements regarding:

- length of the upwind leg;
- length of the course;
- minimum distance of any mark to the shore;
- any other requirements.

Other points of consideration are:

- the shore profile (effects from mountains, valleys, rivers, urban areas, etc. A high shore profile will require more distance from shore than a flat land profile. The farther the distance the higher waves);
- shallow obstacles, sand bars, etc.;
- water depth and type of bottom. (The nautical chart will dictate the length of anchor lines and the type of anchors);
- empirical data and knowledge of local wind patterns and currents;
- tides;
- maritime routes;
- fishing areas;
- any governmental rules for the area.

Also consult with local fishermen, Clubs and navigators for additional information. The Maritime Authority should also be contacted and Notices to Mariners consulted.



ISAF RACE MANAGEMENT MANUAL

SECTION K

The Start of the Regatta

Contents

Page

K The Start of the Regatta

K 1	Registration	K 2
K 2	Measurement and inspection	K 2
K 3	Team Leaders, coaches and competitors meetings	K 3
K 4	Race Officials meeting	K 4

A regatta usually begins with the reception of the competitors. Regardless where they are coming from – from overseas or the neighbouring club, they should get a warm welcome by the hosting authority or club. In this chapter the initial steps and formalities such as registration and handing out regatta documents are presented. Measurement and inspection procedures have to be coordinated and finally, the team leaders, coaches and competitors briefings give the Race Committee a very good opportunity to build up personal contact with them.

K.1 Registration

Registration (see also Section F, Chapter F.3) is a simple procedure by which a competitor makes a formal contact with the Regatta Organizing Committee, a kind of "report in".

While entries are usually sent before a date well in advance the regatta, the registration is the operation through which the organizing committee fixes the number of participants that will compete at the event.

During the registration procedure, the competitor usually shall:

- provide a proof of identity;
- present a valid MNA license, class membership or other document as required by the Notice of Race;
- present a valid measurement certificate;
- provide or obtain the required insurance policy;
- pay the entry fee (if it was not made in advance);
- pay the damage deposit if required (when boats or other equipment is supplied by the organizers);
- sign the organizers waiver of responsibility.

Depending of the type of regatta, registration is subject to some measurement controls, until this stage is not done, registration will not be completed.

Once all those steps have been fulfilled, the boat is registered. She will be given a copy of the Sailing Instructions and Measurement Instructions (if any) and is entitled to start.

Registration is also an opportunity for distributing competitor's packet, if one has been prepared. Such a packet may include sponsors' gifts, a local map, public transport information, programme and anything else that is relevant, not directly related to racing. It is also an opportunity to introduce visiting competitors to local people and generally to make them feel welcome.

K.2 Measurement and inspection

This has been referred to in Section F, Chapter F 7, in connection with the Measurement Committee. The requirements will vary from a simple acceptance of a previously obtained measurement certificate or registration on one hand, to a complex series of checks on the other.

The purpose is to ensure fairness in class racing and to make certain that no competitor has an unfair advantage through deliberately or inadvertently infringing the Class Rules.

If there are special requirements for measurement, they should be included in the Notice of Race. The Sailing Instructions shall then, when appropriate, specify the measurement or inspection procedure (see RRS J1.2; J2.2). Usually measurement matters have been completed before the first day of racing, but under certain circumstances a boat may deliver her measurement certificate, if required, before the end of the event to the Race Committee (see RRS 78).

K.3 Team Leaders, coaches and competitors meetings

Regattas vary greatly in both duration and content of the meetings. For many smaller events meetings are not even considered necessary. However, meetings may be very helpful in building up relations between the Race Officer/the Race Committee and the team leaders, coaches and competitors.

Although the racing areas should be as "neutral" as possible, they often give advantage to local competitors. Such advantage extends to knowledge of shore facilities and even to familiarity with the officials. A meeting can be of benefit in countering some of these advantages. To this end its prime purpose could be described as countering differences in familiarity with local scene thereby contributing to the fairness of the competition.

The first meeting usually precedes the practice race or the first race and may be undertaken either by the Chairman of Organizaing Committee or by Principal Race Officer or any Race Officer for "his/her" classes, if there are several racing areas being planned. The following subjects may cover the meeting include:

- a friendly welcome;
- introduction of key regatta officials;
- identification of main shore locations (Race Office, Protest Room, etc.);
- location of the Official Notice Board;
- identification of Committee Boats, Marks, etc.;
- hazards and prohibited areas;
- racing area(s);
- food arrangements;
- social arrangements;
- prize giving;
- specific rules of the Host Club;
- etc.

Because the meeting has no authority in terms of the rules and the Sailing Instructions, any statements if made are not subject to protest and there is a responsibility upon the official conducting it to exercise great caution not to mislead.

Sailing Instructions should be unambiguous and not require further explanation, nevertheless an important remarks or a question from someone may arise. To act correctly you should ask for such questions to be submitted in writing even this might look too formal and it would not contribute to facilitate the communication between Race Officials and competitors.

It is important that the Race or Protest Committee reply to them in writing by posting both a question and answer on the Official Notice Board.

K.4 Race Officials Meeting

In multi classes events the PRO should arrange a pre-regatta meeting with all ROs to discuss logistics of the regatta, each person's responsibilities and to confirm the way of communications between them.

ROs should also run a meeting with their race committees to confirm all duties and to answer questions if any. This meeting should cover all aspects of the event so they all know their responsibilities so that the regatta runs as smoothly as possible.

Subjects which may be covered at Race Officials meeting include:

- a friendly word of welcome;
- introduction to key people;
- practical information;
- food;
- timetable;
- boats;
- fuel;
- organization on the racing areas;
- boats;
- material's check (marks, flags, boards, horn, forms, etc.);
- morning briefing;
- on the water organisation (see part L: "Setting the course");
- information to the RO during the course;
- incidents reports;
- way to transmit the results ashore;
- procedures at the end of each days (rounding forms, finishing order, protest times, etc.)



ISAF RACE MANAGEMENT MANUAL

SECTION L

Setting the Course

Contents	Page
L Setting the Course	
L 1 Locating the Race Area	L 2
L 2 Position of the Race Committee Signal Boat and the leeward Mark	L 2
L 3 The starting line	L 3
L 3.1 Length and direction	L 3
L 3.2 Line bias	L 4
L 3.3 Inner Limit Mark	L 5
L 3.4 Correcting the line	L 5
L 3.5 The Pin End	L 5
L 3.6 Line boat action	L 5
L 4 The windward leg	L 6
L 5 Laying the other marks of the course	L 7
L 5.1 The Triangle-Windward/Leeward Course	L 8
L 5.2 The Olympic Trapezoids (Inner and Outer Loop)	L 10
L 5.3 The Windward/Leeward course	L 12
L 5.4 The Slalom Finish course	L 13
L 6 Adjusting a Course for Wind Changes	L 13
L 6.1 Race Committee action	L 14
L 6.2 Windward leg	L 14
L 6.3 Leeward leg	L 14
L 6.4 Adjustment procedure	L 15
L 6.5 Trapezoid courses; shortening and lengthening of legs	L 16
L 7 Adjusting a course for currents	L 17
L 7.1 General effects of a current	L 17
L 7.2 Effect on the starting line	L 18
L 7.3 Effect on the windward leg	L 18
L 7.4 Effect on downwind legs	L 19
L 7.5 General	L 19

This chapter details the procedures for setting the course, beginning with locating the starting vessel in a suitable race area and ending with setting the finishing line. Instructions to course-setting boats are also included. The philosophy and the shapes of Triangle courses, the Windward/Leeward, the Trapezoid Inner and Trapezoid Outer are discussed – also considering the new focus on time rather than on distance. Finally, effects of wind changes and current are explained and possible measures to compensate are specified.

L.1 Locating the Race Area (see chapter J.5)

It is assumed here that the race course will be purposely set for the races that are to take place, using separate marks and starting and finishing lines to be positioned depending on the wind direction. When racing is to take place around fixed harbour buoys or landmarks, the positions of starting and finishing lines may vary depending on the wind direction.

Some clubs have a designated race area that may even be indicated on the chart. With a set of coordinates, each Club's Race Officer will therefore always lay his course in the same area. For multi-course regattas, each Race Officer will also be allocated a Race Area beforehand, again defined by a set of coordinates.

If the Race Officer has to pick his own spot, the following applies: To set a course he will need to be competent in some basic geometry or enlist the services of someone who is. He will need a chart of the racing area showing relevant features which can be used for fixing positions, a cardboard shape or an outline on clear plastic film (e.g. overhead transparencies) of the desired shape made to the chart scale, instruments for transferring compass bearings to or from the chart, and a method of marking off distances.

In enclosed waters, the course shape will reveal how much flexibility the Race Officer has in placing the course with regard to the wind direction. It may also indicate to him that a starboard hand course is necessary, although a port hand course is always preferred to facilitate rounding at the windward mark (rule 18.3 is specifically drafted for that purpose).

In open water, the procedure is simpler but there are fewer features and transits available to check the locations of the marks and therefore the length of the legs. The Race Officer is then dependent on carefully calculated time-distance runs in order to establish a windward leg of the length required.

These days, of course, course-setting boats may have all sorts of navigation electronics on board. It makes sense, however, to know how to do it the old-fashioned way, in case the electronics should fail.

The following is a proven sequence for course-setting (continued throughout this chapter):

L.2 Position of the Race Committee Signal Boat and the leeward Mark

If the wind is steady, move to a leeward location within the designated racing area.

Once the racing area is fixed, locate the intended position of the Starting vessel on the chart by means of compass bearings, back-bearings, and transits, from identifiable features, or by using a GPS device.

Record the average wind bearing and transfer it to the Race Committee Signal Boat position on the chart. Remember that a wind vane must always be used in clear air, not where air

flow is disturbed by a part of the Race Committee Signal Boat. The best place is usually the bow.

Attached two spreadsheet files that can help to determine and control wind evolution (L2-wind-evolution-auto.xls and L2-wind-evolution-hand.xls).

Once the mean wind has been established, the Race Officer should compare this with the forecast wind. If the actual wind matches the predicted wind then locating and anchoring the Race Committee Signal Boat is fairly straight forward. However, frequently in some parts of the world, the actual wind does not always match the predicted wind.

Under these circumstances the Race Officer has to decide which way the wind is likely to move during the period when racing is to take place. This is one of the first judgments that the Race Officer makes. Local knowledge of the micro-climate of the race area is an essential element in making this judgement. This is particularly difficult if the Race Officer is not a local man. Having someone with good local knowledge on the Race Committee Signal Boat is essential when this situation arises.

To save time and energy, a good Race Officer will position his committee boat within his designated race area, to take into account any future wind shifts, thus allowing him to pivot the course on the position of the Race Committee Signal Boat.

Place the course shape described above on the chart to define the course and possible changes, to determine suitability with regard to foul ground, headlands, shipping channels, etc.

When satisfied, anchor the Race Committee Signal Boat and recheck position. Note that the Race Committee Signal Boat is always positioned at what will become the starboard end of the line.

When anchoring consideration should be given to letting out a little extra anchor line as this will give you the opportunity of making minor last minute adjustments to the starting line (before the Preparatory Signal) by either pulling in or letting out further anchor line.

Advise the other Committee vessels – and the other Race Officers, if any – immediately of your anchoring position and your wind direction. This information will help the other on-the-water-managers to establish their own courses and will avoid conflicts between neighbouring race areas.

Continue to check wind direction.

L.3 The starting line

L.3.1 Length and direction

The next task is to lay the starting line, which needs to be of the required length. There are a number of rules of thumb for determining this. Commonly used guides are 1.1-1.5 times the sum of the lengths of the boats in the fleet. Some Race Officers regard this as too generous. The wind and sea conditions as well as the manoeuvrability of the racing boats should be considered.

There is a considerable difference between an Optimist dinghy and a 20 metre offshore boat in their requirements for space to manoeuvre. This is where the judgement of the Race Officer is crucial to a good start.

The quality and experience of the fleet is also a crucial factor. In the Olympic Regatta and in those classes who reduce fleet size for their final rounds in their major championships, almost every boat will require a space on the start line. Therefore the above formula in calculating the length of the line is correct. However, where every boat that enters the competition, is allowed to start at the same time, then it is inevitable that the less experienced sailors will be in a second or third rank behind the starting line, at the start. This makes the starting line, using the above formula, too long.

A very long starting line presents other difficulties for the Race Officer. With very large fleets some starting lines have been over one mile in length. Frequently the wind is different at either end and even, at times, in the middle of the line. Another difficulty encountered by Race Officers under these circumstances is to clearly identify boats that are OCS.

Reducing the length of the starting line to a manageable length gives the competitors a better chance of a 'fair' start, and also gives the Race Officer a better chance of getting the fleet away first time without having to resort to penalty flags.

The opportunity for the Race Officer to achieve this is in the initial negotiations with the class, when he should endeavour to persuade the class to reduce starting line length by utilising a suitable competition format requiring less boats on the starting line.

Below is a guide to the length of the starting line for the different events in the 2016 Olympic Sailing Competition. It may be advisable to use a larger multiplier in strong winds. Laser range finders should be used from the port end towards the Race Committee Signal Boat.

Class	Boat Length	Multiplying Factor
RS:X Men	2.86	1.5 - 3
RS:X Women	2.86	1.5 - 3
Finn	4.54	1.5
Laser	4.24	1.5
Laser Radial	4.24	1.5
470 Men	4.70	1.5
470 Women	4.70	1.5
Nacra 17	5.25	2
49er	4.90	2
49erFX	4.90	2

L.3.2 Line bias

It was customary to lay a starting line with approximately 5° of bias favouring the port end. The purpose of the bias is to encourage the fleet to make use of the whole line instead of just the starboard end. Too much bias may lead to congestion at the port end as boats compete with each other to take advantage of it. The Race Officer should observe how the fleet reacts to the bias on his first starting line and adjust as required for subsequent starts.

This is no longer the case.

Race Officers are advised to set a square starting line. That is a starting line that is at 90° to the average wind direction that has already been established. Once laid this starting line can be 'fine tuned' by moving either end of the starting line by paying out or taking in, the anchor line. To get the starting line adjusted correctly the Race Officer should watch the fleet as they test the line for any advantage. If the fleet starts to favour one end over the other, then, if there is time, the Race Officer may adjust the line as previously described.

Whatever happens, the line must be fixed by the Preparatory Signal. No further adjustments can be made after this signal is displayed.

L.3.3 Inner Limit Mark

If an Inner Limit Mark ("ILM") is required it may now be laid. This mark protects the Race Committee Signal Boat from competitors. An Inner Limit Mark should be set as near as possible to the line but never more than a half boat length to leeward of it. If it is too far to leeward, boats may be able to pass between the mark and the line towards the Race Committee Signal Boat while still satisfying RRS 29.1 and 30.1.

To protect the Race Committee Signal Boat an alternative is to attach the mark to the Committee Boat on a short line. This becomes a permanent attachment and is considered part of the Race Committee Signal Boat. It also keeps boats away from a stern anchor warp if one is used.

L.3.4 Correcting the line

Remember that under RRS 27.2, the Race Committee may shift a starting mark at any time prior to the Preparatory Signal or, put the other way, all starting marks must be laid not later than the Preparatory Signal. Thus, with subsequent starts the starting line cannot be adjusted without delaying the starts.

See also paragraph L.8.2 below, which deals with the effects of current on the starting line. For information how to deal with starting problems related to the starting line, please see also Chapter M.3 and Section S on Race Management Policies.

L.3.5 The Pin End

The Pin End mark (also referred to as the "ODM", the Outer Distance Mark) can take two forms:

- It can be a boat with a mast designating the starting line (required at major events).
- The alternative is to use a buoy with a flag displayed (or a distinctive colour inflatable buoy), as the other end of the starting line.

The advantage of using the first method is the line boat always being in position to sight along the starting line and can also be used for making quick adjustments to the line as described in L.2 above.

This is especially useful with a big number of starters or when the line is long.

However, because that mark is a boat it should be as small as possible not to make difficult the start of port-tackers approaching to that end to take the start.

L.3.6 Line boat action

The Line boat proceeds in the right direction (wind direction minus 90°). Once the correct length has been reached (with a log, or time-on-distance calculation), the Line boat proceeds slowly to windward until reaching the anchoring point according to the depth and sea bottom type and making some allowance for tidal flow, if any.

Once the anchor holds to the bottom, the Lineboat eases anchor line until the Race Officer, after checking the line is nearly square to the wind, gives a signal to make fast the anchor line.

For this the Race Officer needs a wind vane with a 90° sighting device or use of a hand-bearing compass. He takes up a position at the staff on board which defines one end of the line, and with the wind vane held in clear air, sights at 90° to the vane. If this is not possible, use a hand-bearing compass. The line personnel on the Race Committee Signal Boat should make sure that they can sight the line any time: they need to stand approximately 1 metre behind the mast or pole which marks the starboard end of the line.

The lying method is nearly the same when the pin end mark is a buoy.

A simple method of checking the angle of the starting line is to wait until the Race Committee Signal Boat is laying either directly into the wind or in a direction parallel to the course to the first mark and then sight the pin mark along a bulkhead or some other right angled part of the Race Committee Signal Boat, this will give you a very accurate reference.

Where there is no line boat available, the Race Officer can lay the pin end first and then take his committee boat and anchor that relative to the pin end buoy.

L.4 The Windward Leg

If there is going to be a leeward Mark in front of the starting line (Mark 3 in the "old" Olympic course; Mark 4 in case of the new "trapezoid" course), the course-setter sails halfway down the line, then heads up 90° ending up head-to-wind and dropping the Mark approximately 0.1 to 0.2 NM (or less) to windward of the middle of the starting line.

The first windward leg is thus extended. Apart from giving a longer first beat, this is also a better situation when multiple starts are required. Once the first class has started, if the second or third class has a general recall or two, the first boats away could be arriving at the leeward Mark while starting procedures are still taking place.

When satisfied that the wind is steady enough within its fluctuations to warrant course setting, dispatch the course-setting boat with specific instructions that will give the desired course length and direction, e.g., for a windward leg of 1 NM and a wind of magnetic bearing 55°, the instruction would be: "From the leeward Mark, proceed 55° at 20 knots for 3 minutes".

From the chart, provide information which will enable the course-setting boat to check its position. The Race Officer may be able to calculate the compass bearings of two identifiable features or there may be a harbour feature close enough for a reliable assessment of distance. Keen competitors will be quick to complain if a significant error is made and then the whole Race Management is called into question. When the course-setting boat is in position to lay the weather mark he should radio the Race Officer on the Race Committee Signal Boat who should then the course-setting boats position and confirm that it is the correct position to lay the mark.

The above is a possible procedure if everything goes well. Sometimes wind or tide or both combine to frustrate the Race Officials. In light winds the Race Committee Signal Boat may not stay on station but drift with the tide. Stern anchors are to be avoided if possible but if one must be used it should be laid with a weighted warp and marked with a buoy. If a GPS is being used to lay the course either of the following procedures should be adopted:

- (a) When the Race Committee Signal Boat is on station it can plot its position on a chart using the GPS or by any other means. The course chosen for the race is then plotted on the chart and the coordinates for each of the marks are calculated and relayed to the course-setting boat that then puts the coordinates into the GPS as way

points. The course-setting boat then simply proceeds to the waypoints and lays the appropriate marks. For course changes the procedure is repeated. This assumes that the Race Committee Signal Boat has a chart table or similar, large scale charts, the time and ability to plot the course and extract the information required and the means of relaying the detailed information (lat and long down to three decimal places) and that the course-setting boat has a GPS that will easily allow the input of manual waypoints. This method does not allow for fine-tuning of the course prior to the Preparation Signal, as time may not allow new coordinates to be plotted and relayed to the course-setting boat. It also makes “eyeballing” the weather mark and getting a good wing mark difficult.

- (b) The course-setting boat acting upon instructions from the Race Committee Signal Boat to lay the weather mark at say “1NM on a bearing of 195° ” proceeds to the centre of the starting line and enters that position as a waypoint of the GPS, way point 10 for example and records this waypoint number as the centre of the starting line. The course-setting boat then proceeds up wind for 0.1-0.2 NM. and positions the leeward Mark. After allowing the mark to settle the course-setting boat approaches along side and enters that position as the next waypoint (eg 11), and records this number as the leeward mark. The coxswain then calculates the back bearing of 195° s (015°) and sets the GPS into “GOTO” mode and nominates the waypoint for the leeward mark (number 11 in this example). The course-setting boat then heads off on a bearing of 195° with the coxswain checking the back bearing via GPS. When the bearing and distance to the waypoint is 015° and 1 NMm. the coxswain checks with the Race Committee Signal Boat to ensure the course-setting boat is in the right position and to allow for any changes in wind direction. If given directions to move left or right the back bearing on the GPS will change and this can be used to calculate the new wind direction. After the weather mark is laid and allowed to settle the course-setting boat approaches alongside and enters that position as the next waypoint (eg 12) and records this number as the weather mark. The coxswain calculates the bearing to the wing mark and sets the GPS to “GOTO waypoint 12 in this example. The coxswain then proceeds in the direction of the wing mark using the back bearing on the weather mark to correct any drift. When the back bearing and distance to the weather mark (12) is correct the coxswain can select “GOTO” waypoint 11 to double-check this position against the leeward mark. Once this mark has been laid it’s position should be entered as another waypoint (13). If a trapezoid course is being used then this can obviously be extended. If a change of course is required the Race Committee Signal Boat then relays the course using the stored leeward mark as the reference point. This method also means that the course-setting boat can check any of the marks for drift by comparing their current position against the GPS waypoints.

L.5 Laying the other marks of the course

Up to this point the procedure is the same, no matter what type of course is used, as long as it starts with a beat.

Some years ago, there was really only one acceptable course to lay, especially in open waters. This was the so-called Olympic Course, which consists of a triangle, a loop (the sausage) and a final beat. Sometimes it would have an extra triangle added and be called the super-Olympic Course. Many course experiments have been taking place, and the result has been the introduction of a number of new Olympic Courses in respect of the 1996 Olympic Games. However, experiments will go on and produce new course options. For the courses most frequently refer to the current Racing Rules of Sailing (RRS) Appendix L, Addendum A (Illustrating the Course).

In the following sections the particulars of all types of courses will be described. Which course is to be selected is usually a decision for the Race Committee and the Class(es) involved.

L.5.1 The Triangle-Windward/Leeward Course

The course is as follows:

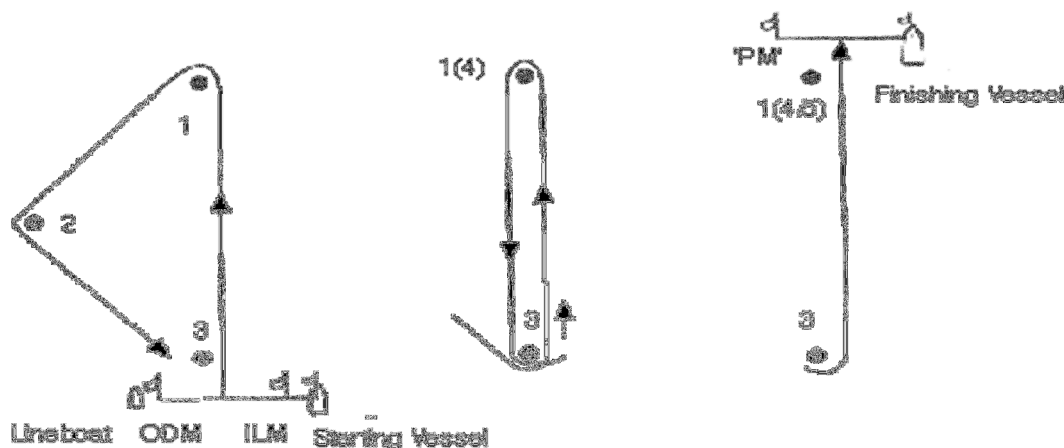

The first leg of the triangle is the windward leg, bounded by marks conventionally numbered "3" (the leeward mark) and "1" (the windward mark). The "apex" or "gybe" mark is conventionally numbered "2".

The commonest triangle is the 90-degree-angled isosceles triangle ($45^\circ-90^\circ-45^\circ$) with the 90° angle at the gybe mark. Classes which close-reach well under spinnaker may prefer an equilateral triangle ($60^\circ-60^\circ-60^\circ$).

Some multihull classes may use a scalene triangle (unequal sides) with a shorter, close first reach (usually 75°), and a longer, broader second reach. A multihull triangle can be something between $75^\circ-60^\circ-45^\circ$ (earlier type) and $75^\circ-85^\circ-20^\circ$ (recent type). Especially the length of the first reach may be different: Some classes like very short first reaches, others like longer ones or even no reaches at all (so that the course becomes just windward/leeward - see L.6.4).

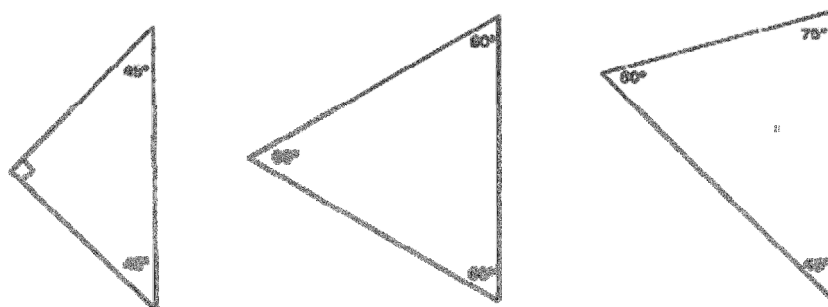

Left: the standard $45^\circ-90^\circ-45^\circ$ triangle. Middle: the $60^\circ-60^\circ-60^\circ$ equilateral triangle. Right: the $75^\circ-60^\circ-45^\circ$ scalene triangle.

The Race Officer instructs the course-setting boat to proceed from Mark 1 on the compass bearing required for Mark 2.

To calculate this, take the direction from Mark 3 to Mark 1 and subtract 135° for a $45^\circ-90^\circ-45^\circ$ course (subtract 120° for a $60^\circ-60^\circ-60^\circ$ course; and 105° for a course with a close first reach with a 75° angle).

The Course Setter continues on this course, looking back to Mark 1 every now and then to verify his bearing and, if necessary, correcting for waves that push him further inside the triangle. He proceeds until Mark 3 lies on the correct bearing from his new position.

On the standard right-angled isosceles triangle, the Course Setter has reached his new position when he sights Mark 3 at a 90° angle to his left, i.e. when he subtracts 90° from his current bearing. From the Race Committee Signal Boat the bearing should be checked (the direction from Mark 3 to Mark 1 minus 45°). Keep in mind that the Race Officer on the Race Committee Signal Boat is probably not lined up with the two marks, so the position of Mark 2 will always look slightly off to him.

The Table of Bearings in Appendix F9 may be useful. With the triangle complete, the course is now basically laid.

The wind direction is continually checked by the Race Committee Signal Boat and all Mark boats. The Race Officer may have to swing the course one way or the other if the wind backs or veers with any degree of constancy. If the wind reading is different from that at the windward mark, the Race Officer must decide whether to compromise or accept one or other of the readings. The other possibility is to wait for overall constancy but then a successful race may be put in jeopardy by excessive caution.

The finishing line is not set until the race is well on its way. It is customary for the Race Committee Signal Boat to remain as a Mark boat, that is to say, a boat that is assisting in making the proximity of a mark apparent to competitors, until the leading boats are approaching the completion of the triangle. The Race Committee Signal Boat then makes its way to windward and proceeds to set the finishing line.

Especially if there are several races scheduled per day, with each race having a limited duration of 35-90 minutes, it is advisable for the Race Committee Signal Boat to remain on station at the leeward mark and delegate another craft the task of managing the finish (a separate "Finishing vessel").

The final beat may be extended by positioning the finishing mark some distance to windward of Mark 1. The reasons for setting up a separate finishing line are similar to those mentioned for setting the starting line to leeward of Mark 3: it creates more windward work and leaves Mark 1 clear of finishing boats. This is especially valuable if the Race Officer wants to change the direction of the final leg because of a wind shift. Without a separate finishing line he would not be able to do this in the case of a drawn out fleet with tail-enders, or a fleet that started later, still rounding Mark 1. Mark 1 would not be included as a mark of the course for boats sailing the final beat to the finish.

Whether the finishing line is contiguous with Mark 1 or some distance to windward of Mark 1, the procedure for line setting is the same. The Finish Boat anchors so that the line between the staff at one end and the mark (either Mark 1 or a separate Finishing Mark) at the other is at 90° to a line to the leeward mark (i.e. not necessarily also at right angles to the original or current wind direction!!!).

While the starting line is set approximately at 90° to the wind, the finishing line is set at 90° to the last leg of the course. On many occasions this will also be at 90° to the wind direction but is not necessarily so. The Finish Boat should normally be at the starboard end of the finishing line for a port hand course and the port end of the finishing line for a starboard hand course. This ensures that boats take the finishing mark on the same side as all previous marks of the course.

Boats finishing should be kept away from the anchor line of the Finish Boat, particularly when the water is shallow and the anchor rope is at a flat angle. One way of doing this is to tie a floating indicator to the anchor so that competitors know where it is. The finishing line as a whole should be long enough for boats to pass safely between the anchor and the other end of the line. The other - more effective - way is to lay the port end finishing mark slightly closer to the last mark of the course - providing a slight bias to the pin end. This will attract boats to the pin end and keep them away from the Finish Boat.

L.5.2 The Olympic Trapezoids (Inner and Outer Loop)

The Inner and Outer Loop course have nearly the same course configuration, but the order in which the marks must be rounded is different. In addition, with the Inner Loop the leeward mark next to the starting line (now usually called Mark 4) is replaced by a Gate (described as 4G; or as 4P – 4S), i.e. two marks lying at 90°, approximately 6-8 boats lengths apart, to the windward mark. Either of these is to be rounded (port or starboard) when coming downwind from the windward mark and after having first sailed through this gate (passed between both marks from the direction of the windward mark).

On the Trapezoid Inner Loop boats sail: S-1-4G-1-2-3-F

First they sail a windward/leeward. After rounding Mark 1 for the second time they go on a short tight reach to Mark 2, then on a run to Mark 3, and then to the finishing line on another tight reach, leaving all marks to port. If the overall distance of that course seems to be rather short for the prevailing weather conditions, the Trapezoid Inner Loop can be extended by adding an extra windward/leeward: S-1-4G-1-4G-1-2-3-F, or two extra windward/leeward (see Chapter J.3.4 for course descriptions and their identification).

The Trapezoid Outer Loop consists of a beat, then a close reach, then a run, followed by a windward/leeward around Marks 2 and 3, and finally a tight reach to the finishing line, also leaving all marks to port: S-1-2-3-2-3-F

Also the Outer Loop may be extended by an extra windward/leeward to a Trapezoid Outer Extra: S-1-2-3-2-3-2-3-F. As with the Inner Loop, the leeward mark 3 may be replaced by a Gate, mark 3 then becoming mark 3G.

Frequently, with more than one Class or various groups of the same Class on the course, the first fleet(s) will sail the Outer Loop and the later starters the Inner Loop. It is fair to say that the risk of congestion at the leeward mark is far greater with the Inner Loop, since there is no early reach to spread the fleet out a little.

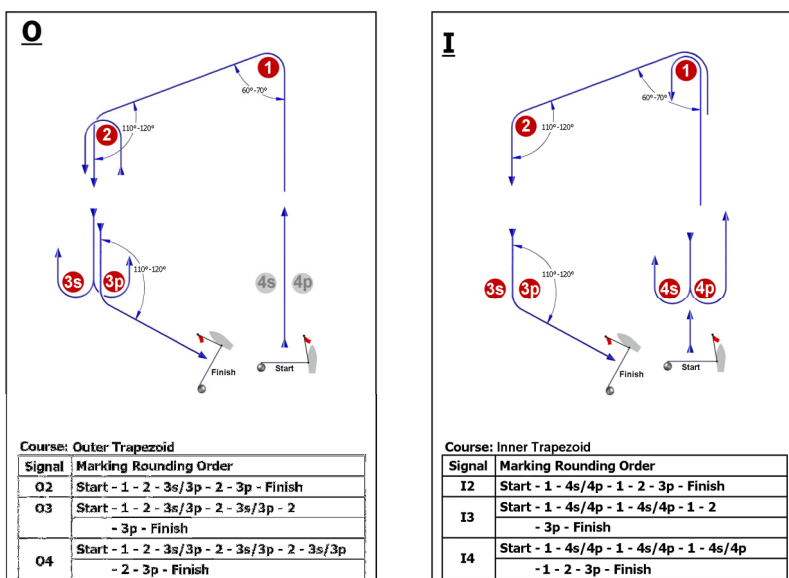

The Olympic basic trapezoid courses. Left: the Outer Loop. Right: the Inner Loop.

Frequently, with more than one Class or various groups of the same Class on the course, the first fleet(s) will sail the Outer Loop and the later starters the Inner Loop. It is fair to say that the risk of congestion at the leeward mark is far greater with the Inner Loop, since there is no early reach to spread the fleet out a little.

Another option (not illustrated here) for the Trapezoid Outer Loop is having an upwind finish, with the finishing line being set windward to mark 2.

Because actually the key factor in laying courses is time, not distance. More wind means longer legs, while in less wind the course must be "shrunk". With an e.g. 60-minute target, the marks are usually sufficiently close to lay the marks on eyesight. With the Inner Loop, again the Course Setter can afford to delay laying Marks 2 and 3 if he is expecting a wind shift.

The angle of at least one of the reaches is determined by the close-reaching characteristics of the Class(es) on the course. For single-handlers an angle where competitors have to hike hard and work the sheet all the time is ideal. For boats with spinnakers, the angle should be such that the spinnaker can only just be carried. These aspects, too, are clearly dictated by wind strength.

Trapezoid courses offer experienced Race Committees the possibility –if local conditions permit- to lay the final legs quite late, i.e., while the race is already underway. By doing this, the second windward/leeward leg can be adjusted to the wind direction if the Race Committee should find that its original choice of direction for the first windward leg was not the best one possible. There is thus a good opportunity to correct for e.g. the wind shift at a late stage and lay a perfect second beat, run and reach after the shift has come through. However, this adjustment is difficult or impossible with two fleets on the same course, one sailing the inner loop and the other sailing the outer loop.

The finishing line is located at the leeward end of the course, not far away from the starting area. This allows shorter time intervals between the finish of one race and the start of the next one. Remember that one of the reasons for the new courses is not only to allow shorter races, but also to be able to sail more races per racing day.

If the finish is on a reach the position of the Finish Boat is very important; first, because it is more difficult to read the sail numbers of boats crossing the line on a reach than it would be if they were beating to windward; secondly, because racing tactics on the last reach could involve boats luffing in an attempt to force a competitor to the wrong (that is windward) side of the finish.

Experience so far has proven that the best place to position the Finish Boat is at the windward (port) end of the finishing line (a port hand course is assumed). It may be slightly more difficult to read sail numbers in this position, but it is safer than the leeward (starboard) end of the line, because competitors can see the Finish Boat itself much better than its anchor line and can therefore judge the amount of space available much better.

To solve the problem of reading the sail numbers, one option is to have a small boat at the starboard end of the finishing line (a port hand course is assumed), which records all the sail numbers without worrying about the exact finishing order. This boat does not need to anchor and could even position itself slightly to windward of the middle of the finishing line.

L.5.3 The Windward/Leeward course

This course only has two marks: Mark 1 as a windward mark, and Mark 2 as a leeward mark (otherwise also called Mark 3). Again, as with the Trapezoid Courses, the leeward mark may be replaced by a Gate (then mark 2 becomes mark 2G). This gate consists of two marks at a 90 degree angle to the windward mark.

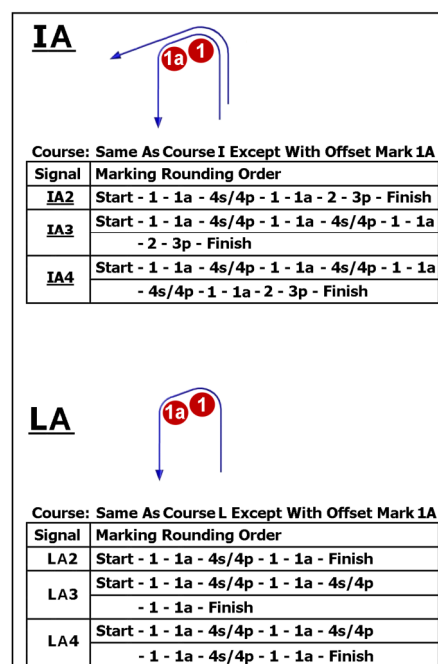
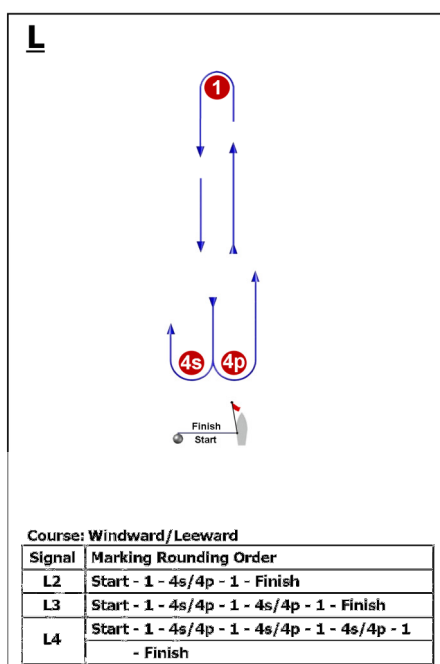

Windward and leeward mark will usually be laid to windward of the middle of the starting line. It is easily adjusted in the event of wind shifts, because no other marks need to be shifted to maintain the course configuration.

There are several options for the Windward/Leeward course: at the Olympics 1996, the leeward mark was replaced by a Gate and the finish was downwind. The marks to be rounded were: S-1-4G-1-F. In addition, there was an option to sail one or more extra windward-leeward leg (Windward/Leeward Extra): S-1-4G-1-4G-1-F. As an alternative, there may be an upwind finish in a position to windward of Mark 1 (see also RRS Appendix L, Addendum A).

Some organizers/classes prefer to use an offset mark at the windward mark to ensure that the leaders, on the downwind leg after rounding Mark 1, do not have to cut right through the fleet still coming up. An offset mark may also be used with triangle or trapezoid courses.

The Windward/Leeward is the course that is often used for Match Racing (with all marks to be left to starboard). The length of the legs is then determined by the wind speed and the type of boats racing. A Match Race ideally takes approximately 25 minutes to complete. If the wind drops or picks up, the Race Officer will usually bring the windward mark in or take it further out to ensure that the racing time for each match stays more or less the same.

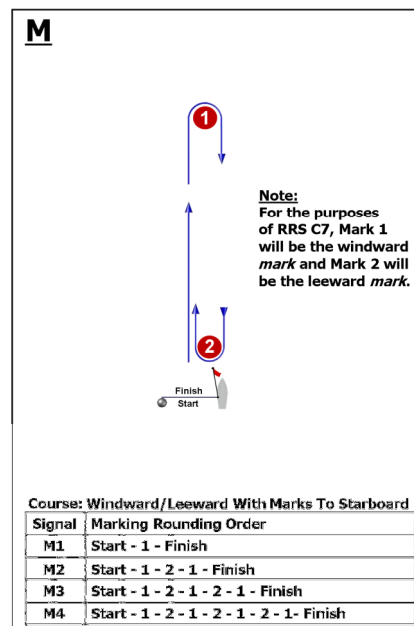

L.5.4 The Slalom Finish course

The following is a variation of the basic Windward/Leeward and Trapezoid courses that combine a classical racing followed by a slalom just prior to the finish. This course adds to boardsailing their specific ability to reach trough a short slalom before finish, provide an exciting and spectacular end of the race.

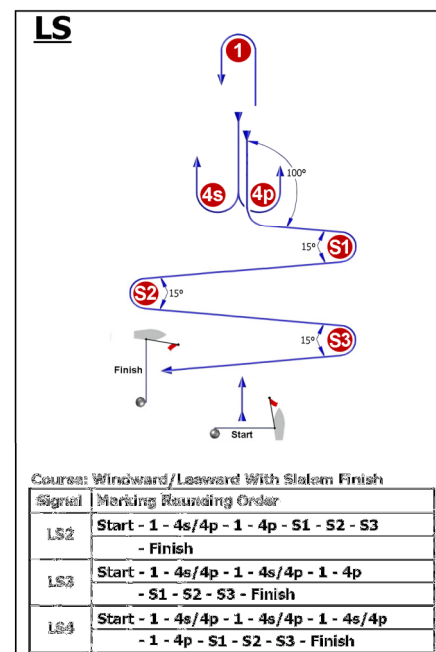
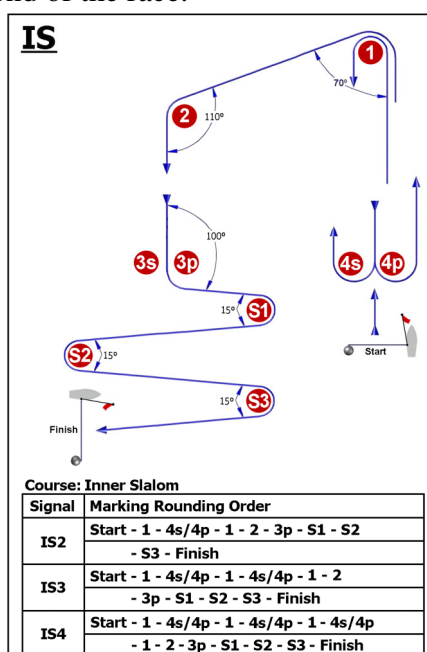
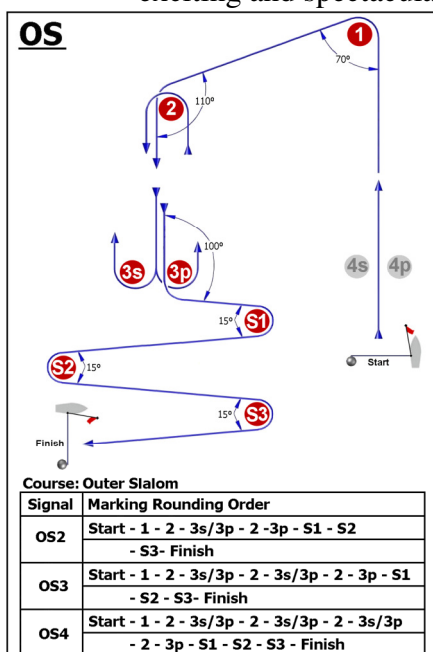

L.6 Adjusting a Course for Wind Changes

This section discusses the importance of a course being correctly oriented to the wind and how courses can be adjusted if the wind direction or the wind strength changes. It applies mainly to longer courses for which eyesight alone is not sufficient, and therefore makes

reference to the "old" Olympic Triangle course. However, the principles hold true for shorter courses just as much.

L.6.1 Race Committee action

At any time before the Warning Signal, by RRS 27.1, the Race Committee has to signal the course to be sailed. If necessary due to early changes in the wind direction or wind strength, RRS 27.1 allows the Race Committee to replace one course signal by another and/or signal that a designated short course is to be sailed.

If it has already given the Warning Signal, the Race Committee may then change a given course signal (still being before the starting signal) by postponing the race (RRS 27.3) and resetting the course.

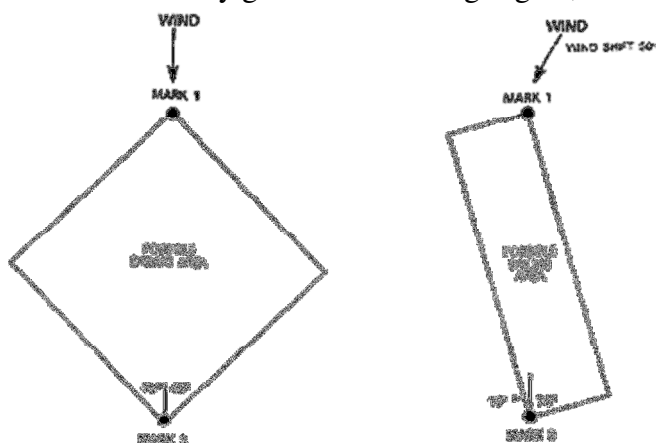

After the start the Race Committee is limited by the Racing Rules and the Sailing Instructions. After the Starting Signal, RRS 32 (e) allows a Race Committee to abandon (or shorten) a race for any reason directly affecting the safety or fairness of the competition. This could include a major wind shift on the first leg. A

race should not be abandoned due to a change in wind conditions after the leading boat has rounded the first mark. Abandonment should only be considered as an action of last resort in extreme circumstances where there is no reasonable opportunity to finish the race. Every effort should be made to finish the race by using all available means such as shortening or altering the course, shortening or extending the length of a leg of the course or any combination thereof.

L.6.2 Windward leg

On a windward leg boats should sail equal times on port and starboard tacks.

If the leg is not true to the wind, sailing distance is reduced and the sailing area is reduced, too. In the left diagram below the sailing area on a beat for boats making good a track 45° to the true wind is shown. It is a square formed by boats sailing on opposite tacks from the leeward mark to the lay lines to the top mark.

The right-hand diagram is the sailing area if the wind veers 30° . The sailing area is reduced by 50% and port tack sailing by 63%. If the wind veers 45° the sailing area becomes a line and the "beat" a procession to the top mark with the sailing distance reduced by 30%.

L.6.3 Leeward leg

On the leeward leg, correct alignment to the wind is probably more critical. Assume the class is one that does not tack downwind and the optimum course lies within 10° of the true wind. If the course is true, midway down a 1.5 NM run, the boats could be spread over a width of 490 m. Thus a boat has room for initiative with respect to following shifts and tactical theories. If the leeward leg is at an angle of 10° to the wind, theoretically, for the boats assumed above, all boats should remain on the same tack and sail on the same line to the leeward mark.

L.6.4 Adjustment procedure

Having established the importance of a course true to the wind, how is the course adjusted? Generally, an adjustment would not be made before the end of the first triangle. When an adjustment is made at this time, the whole course would be rotated about the leeward mark ('Mark 3' in a triangle course).

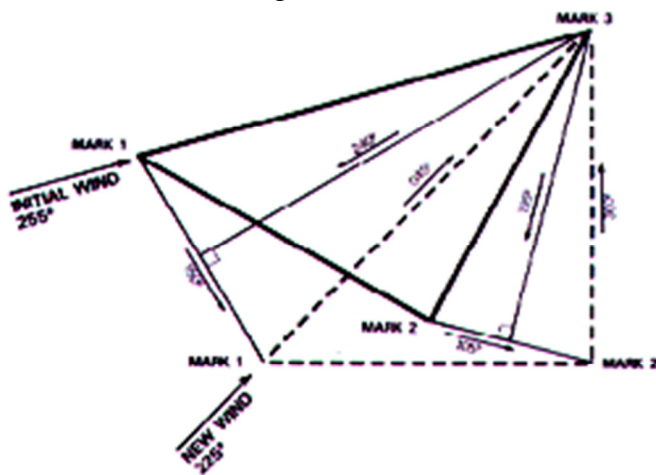

two bearings is 240° . The line at 90° to the average is 150° . Therefore to lay Mark 1' the Mark boat steers 150° from Mark 1 until Mark 3 is on a back bearing of 225° minus 180° , that is 045° . This is shown in the diagram above.

If a further triangle is to be sailed, Mark 2 will have to be moved in a similar manner. If the triangle was 45° - 90° - 45° , the old bearing of Mark 2 from Mark 3 was 210° (port hand course) and the new bearing is 180° . Therefore, the Mark boat steers 105° from Mark 2 until the bearing of Mark 3 is 360° . This is also illustrated in the diagram above.

It is a good practice to announce "standby for a course change", even if it is not proceeded with. The Race Officer must then take the decision, allowing his team enough time to execute course change. However, keep in mind, that any change in a race may cause errors and misunderstandings due to human failures or material shortcomings. Competitors might become irritated, confused or even misled when changes are not executed and signaled in due order. Do not try to be a perfectionist and consider properly if a minor change of the wind direction already requires a course change and, when positive, if your team will be able to manage the necessary action. Usually, a change of course is not necessary with wind shifts of 5 - 15° . Start thinking about a change of course when the wind shift turns out to be of 20° or more.

The actual procedure to do a course change could then be as follows: when the competitors are on the reaching legs of the triangle, a new bearing is determined for the windward mark and the Mark Boat or the Course Setter is instructed to proceed left or right according to whether the wind has backed or veered, until it is on the new bearing (see above).

Appendix F9 gives the appropriate tables, which combine the number of degrees of the shift with the length of the beat, thus giving the angle and distance that the Course Setter must navigate from the old Mark 1 to the new windward mark position. An alternative but more time-consuming procedure is for the Course Setter to proceed from Mark 3 (leeward mark) on the bearing of the new windward mark. If there should be a second triangle, then Mark 2 must also be reset. The new bearings for Mark 2 must be calculated and the attendant course-setting boat or the Course Setter be instructed accordingly.

The change does not have to be "completed", the mark may not be in position before the leading boat begins that leg, but in time to give it due notice of the change and display the bearing of that leg (see RRS 33). Similarly a new final beat can be set while the leading boats are on the square run.

The Mark Boat stationed at Mark 3 (the mark beginning the leg being changed) will receive orders from the Race Officer as to when to display Code Flag C and the approximate compass bearing to the new mark, and to make sound signals periodically. RRS 33, RRS Race Signals and RRS K 11 (Section N in this Manual) give the guidelines to deal with course changes.

Note that it is sometimes necessary to display one or more class flags under Code Flag C, e.g. if the change applies only to some classes in the same race area or to a class whose leaders have overtaken the tail enders of a class which started earlier and which is still sailing the old (unchanged) course.

The Mark Boat (often the Line boat, if it has finished its starting line duties) must be positioned close enough to the mark to ensure that the flag(s) and the compass bearings can be seen and the sound signals heard. It must, at the same time, leave a big enough gap to allow the fleet to get through.

The Sailing Instructions will have spelled out precisely how competitors are to take Mark 3 when the change in wind direction is greater than 90°. The instruction may provide for waiving RRS 28.1. For example: "When the course is changed, boats shall pass between the RC boat signaling the change and the nearby Mark, leaving the RC boat to starboard. In this case, RRS 28.1 is amended so that the string representing a boat's wake shall touch either the Mark or the required side of the RC boat signaling the change of course."

L.6.5 Trapezoid courses; shortening and lengthening of legs

When trapezoid courses are used, it will prove to be more difficult to adjust a course for wind changes while the race is underway. Usually the time available for moving a mark will be short (only a few minutes) and this will require a skilled Race Committee and fast course-setting boats to make it work properly.

At the same time, it is less damaging than on the triangle course if one or two legs should be less than perfect by the time the fleet approaches them, because the races are short. With more races to be started there is always a chance to change the course before the next race. And with the option to lay the final legs very late, there is often a good chance that you can correct for a wind shift at a late stage and lay a perfect last run or beat to the finishing line.

In addition, as the focus with the shorter courses is rather on time than on distance, the Race Committee shall should try its best to adapt the lengths of the legs to meet the scheduled target time for a race as near as possible. Competitors will not be happy to sail two races of 90-100 minutes duration each if they expect one race to last only 60 minutes. Likewise, races of a significantly shorter duration than expected will be unsatisfactory.

The Race Committee may react to changes in the wind strength by shortening or lengthening legs (could be combined with a change of course direction). A Mark boat then has to signal the change by displaying Code Flag C and a '-' if the leg will be shortened or a '+' if the leg will be lengthened (see RRS 33). This gives the Race Committee the flexibility to adjust the length of a leg if the wind is moderating instead of e.g. having to shorten the course by one round. However, as every change increases the chance of an error, the Race

Officer has to consider properly if a (especially minor) change of the length of a leg will make a material difference in the race.

It is difficult to give a rule of thumb when a course change of this kind should be signaled. If visibility is good and the mark to be moved is already in the water as the boats round the prior mark, a change of 15-20% or more of the original length of the leg should be signaled. If visibility is poor, however, or the mark is not yet in place as the boats round the prior mark, even minor changes of the length should be signaled. Again, bear in mind that at all times a course change of the course direction must be signaled before the leading boat begins the leg being changed (see RRS 33) and that on short courses there will be very little time to put the mark in position.

When moving marks, a general guideline for any type of course should be that a mark that is no longer required for racing be removed as soon as the last boat has rounded it.

Competitors can easily get confused if marks that are no longer used are left in their old positions, whilst other marks are moved to new positions. However, be sure that competitors do not get confused by towed marks: These marks may be wrongly identified as the actual marks in position.

L.7 Adjusting a course for currents

L.7.1 General effects of a current

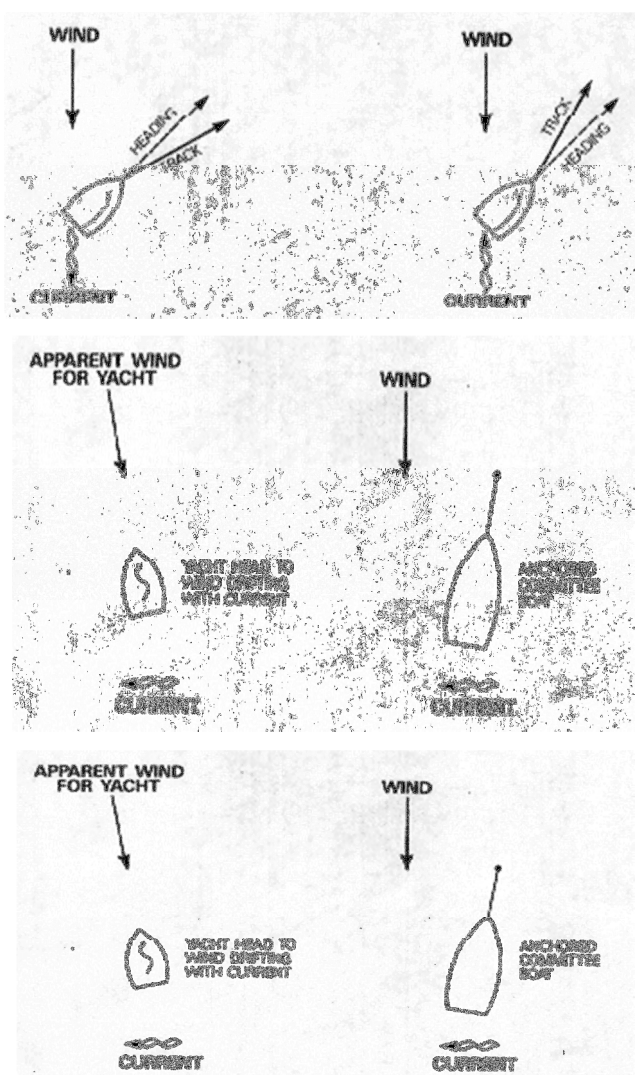

We have considered the effects of wind changes on a course. Now we need to consider currents, usually tidal and therefore varying. Currents are particularly important, when relatively strong and associated with light winds. With anchored marks in a current it is not possible to set a course which is correct for all legs. However, this section considers how the elements of a course are affected by currents and how they may be adjusted.

When adjusting a course in a current a Race Officer must use considerable judgment. If significant adjustments are required it may be wise to delay or racing. With any current the apparent wind experienced by a boat is different from that experienced on an anchored Committee Boat. If the current is in the same direction as the wind, the apparent wind is less than the true wind and a close-hauled boat's track is further from the wind than its normal track. With the current in the opposite direction to the wind the apparent wind is greater and the boat's close-hauled track closer to the wind.

With the current not parallel to the wind the direction of the apparent wind will change. With a true wind of 7 knots and a cross-

current of 1 knot the apparent wind, for a boat stationary in the water, is from 8° downstream of the apparent wind on an anchored Committee Boat.

With a cross-current a beating boat, sailing equal times on each tack, will reach a point some distance downstream of a point directly to windward of its starting point.

L.7.2 Effect on the starting line

With a current parallel to, and in the same direction as the wind, a boat starting on starboard tack passes closer to the pin end mark than it would with no current. With a relatively strong current, boats starting on starboard tack near the pin end may have difficulty in clearing the mark. Some authorities recommend that in these circumstances the line should be biased to starboard to give starboard tack boats a greater opportunity to clear the line. However, the Race Officer must decide if starboard tackers should be favoured over port tack boats. An alternative method to compensate is to lengthen the starting line.

If the current is parallel to and against the wind the most significant problem on the starting line is current-induced barging at the starboard end. This will most likely occur at the starboard end and more port hand bias will alleviate it. The use of a distance mark will protect the Race Committee Signal Boat.

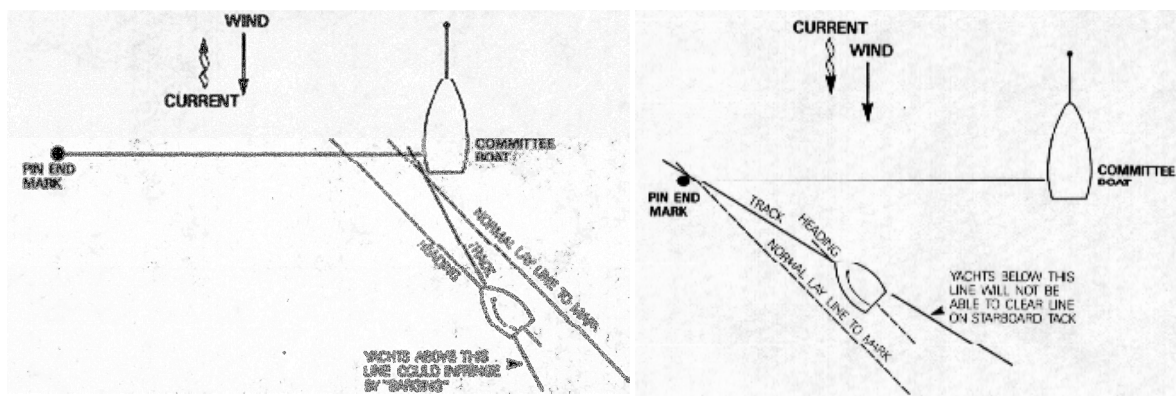

If there is a cross current the starting line should be approximately at a 90° angle, with appropriate bias, to the wind perceived by a boat stationary in the water. This can be calculated by vectors, or a luffing boat can be observed or an unanchored Committee Boat can be asked to take a wind bearing.

A current will normally be constant during a start and therefore it is appropriate to consider adjusting a starting line to allow for it.

L.7.3 Effect on the windward leg

A current parallel to the wind changes the velocity but not the direction of the apparent wind. It also alters the track of close-hauled boats but no course adjustment is necessary to ensure equal times on each tack to reach the windward mark.

The correct bearing to a mark may be altered drastically by a cross-current. A cross-current carries boats downstream while they are beating and therefore the windward mark should be located downstream to ensure boats sail equal times on each tack and fulfil the ideal of maximum sailing area.

The correction required in a cross-current varies with the speed of the boats. The faster the boats the less time they take to reach the top mark and therefore the smaller correction required. In our example in paragraph L.8.1 above, with a true wind of 7 knots and a cross-current of 1 knot the apparent wind was from 8° downstream of the true wind.

If boat speed in these conditions is 4 knots and boats sail at 45° to the apparent wind, the windward mark should be set 26° down the current of the Race Committee Signal Boat.

This leads to a rule of thumb for a cross-current. Assess the difference between the wind directions for sailing boats and the Committee boat by observing boats luffing. Multiply by three and set the windward mark at that angle downstream. For fast boats the correction would be less, to have equal times on each tack while beating to the top mark.

Obviously, from the example above, corrections may become very large. The Race Officer must decide what changes in tidal current will occur during the leg and during the race and set a course to allow for these keeping in mind the effects of the current on the off-wind legs.

L.7.4 Effect on downwind legs

In a cross-current, for a true downwind leg, the bottom mark should be downstream of the direction of the apparent wind. The distance it should be displaced is again dependent on the speed of the boats. Thus, if a true windward beat is set (equal times on each tack) it is not possible to have a true run and arrive back at Mark 3. In fact, the first reach of the triangle may become a run and the second one a close reach. The leg from Mark 1 to Mark 3 would also be a reach. Unfortunately, the Race Officer must accept this effect on the off-wind legs in order to obtain better upwind legs.

L.7.5 General

Current and wind are unlikely to be parallel or at a 90° angle. The easiest method to determine apparent wind is to watch a competitor luffing head to wind.

To determine the correct bearing of the windward mark, have a boat sail from the Race Committee Signal Boat close-hauled on one tack for, say, one minute and then tack and sail on the opposite close-hauled course. The boat's bearing when it has sailed for equal times on both tacks is the required bearing of the windward mark to give equal times on each tack.

A wing mark should be set at the usual bearings from the windward and leeward marks, although this will not give the required reaches. To give correct orientation of all legs, the marks would have to drift with the current with the course orientated towards the apparent wind from a drifting boat! Light winds and strong currents, particularly with slow boats, require large corrections.

In Match Racing two windward marks are often used to compensate for tidal current.

For example, in our previous calculation for the position of the windward mark, for a boat with a speed of 3 knots, the mark should be 32° down current, or four times the difference in wind angles.



ISAF RACE MANAGEMENT MANUAL

SECTION M

Starting Procedures

Contents	Page
M Starting Procedures	
M 1 Starting systems	M 2
M 1.1 RRS26 Starting System	M 2
M 2 The starting procedure	M 3
M 2.1 Guide of actions during the starting procedure	M 3
M 2.2 Sighting the line.	M 7
M 2.4 Communication with the pin end	M 8
M 3 Starting problems and solutions	M 8
M 3.1 Starting line	M 8
M 3.2 Line identification	M 8
M 3.3 Floating lines	M 9
M 3.4 Line adjustment	M 9
M 3.5 Delays	M 9
M 3.6 Boats on the course side of the starting line	M 9
M 3.7 Miscellaneous problems	M 11
M 4 The Gate Start	M 11
M 4.1 General	M 11
M 4.2 Procedure	M 11
M 4.3 Operation	M 12
M 4.4 Natural conditions required	M 13
M 4.5 Equipment	M 13
M 4.6 Other considerations	M 13

This chapter provides guidelines for starting and will discuss RRS 26 the ISAF Starting System. The actions of Race Committee members are given and emphasis is then laid upon starting problems and solutions, also discussing the Starting Penalties I Flag Rule, Z Flag Rule and Black Flag Rule. Finally, the procedure and necessary equipment for Gate Starts are outlined.

M.1 Starting systems

RRS 26.1 sets out a 5-4-1-0 starting system, however, the Sailing Instructions may change RRS 26 by specifying another starting system, considering the advantages of using other time intervals, e.g. 3-2-1-0 (as in many team racing events). Where there are multiple starts the system continues at five minute intervals with the new class flag being displayed simultaneously as the previous class flag is removed.

Where there are large fleets a Signal boat may be stationed between 100 and 200 m to windward of the middle of the starting line. A signal boat so positioned gives competitors a better opportunity to see and hear signals. The line under these circumstances is often between two Committee boats, although the pin end may be a marker buoy with a patrol boat in attendance.

The Signal boat is not anchored and at the starting signal, if the start is clear, it will usually move rapidly to the starboard side of the course. For multiple starts it will then return to station or, if there is only one start, it may assume the role of Lead Boat and proceed to the windward mark.

One of the advantages is that each signal is removed one minute prior to the next being displayed. This not only gives the competitors extra time signals but reduces the confusion which sometimes follows from having multiple signals displayed at any one time. The idea of removing signals before the following signal is being displayed is also part of the new starting system outlined in RRS L 11.1.

Good radio communication from one end of the line to the other and to the Signal boat is important as is radio silence during the start countdown, so that the Race Officer can be heard by all RC personnel. The volume should be reduced so that he is not easily overheard by competitors on the water!

M.1.1 RRS26 Starting System

This system is defined as follows (example below: two classes (A and B) to be started successively at five minute intervals):

Minute, related to 1st starting signal	Title	Flag Signal	Sound Signal
-10	Orange Flag	Starting line flag(s) displayed	1 sound
-5	Warning for A	Class flag A displayed	1 sound
-4	Preparatory for A	Flag P or I or Z or Z with I or U or Black flag displayed	1 sound
-1	(one minute)	Preparatory signal removed	1 sound
0	Starting for A;	Class flag A and other flags removed;	1 sound
+5	Warning for B	Class flag B displayed	
+6	Preparatory for B	P or I or Z or Z with I or U or Black flag displayed	1 Sound
(+9)	(one minute)	Preparatory signal removed	1 long sound
(+10)	Starting for B	Class flag B and other flags removed	1 sound

Race Committees are encouraged to adopt this system in order to be consistent all round the world for the benefit of sailors competing in different regattas

An independent sequence for each class is becoming increasingly common. The reason is to increase separation between classes or groups or to adjust the bearing or length of the starting line, depending, for example, on relative speeds of each class/group.

If the delay is short no signal is needed: competitors are ready to start and do not need an extra warning. However, if there is to be a long delay (e.g., 10 minutes) the Orange starting line flag(s) should be removed with no sound signal and be displayed again when the Race Committee is ready for a new sequence.. The extra time between displaying the Orange starting line flag(s) gives, allows competitors to be ready for their warning signal. This practice shall be stated in the Sailing Instructions. The wording is included in Appendix L under “Schedule of Races”. The interval between the displaying of the Orange starting line flag(s) and the displaying of the Warning Signal is not less than 4 minutes. It is recommended, for the sake of consistency, to be 5 minutes. However, the displaying of the Orange starting line flag(s) is not a signal.

Some examples of situations the Race Officer could consider to delay subsequent starts are: changing weather conditions or if the first class already started is expected to be close to the starting line or if any other circumstance is about to affect the fairness of the succeeding start.

The orange starting line flag(s) is used to alert boats that the starting line is set and a race is about to start. If it is used for a scheduled start it should be displayed 10 minutes before the scheduled starting time (scheduled warning signal time -5)

If either AP or N is displayed, the orange starting line flag(s) should be displayed 5 minutes before the warning signal. The AP or N should be removed 1 minute before the warning signal, according to RRS Race Signals.

At the end of a starting sequence, the orange flag should be removed 4 min after the last start of the series, together with X if any.

Between starts of the same series, it is recommended to wait for at least 5 minutes between the start and the next warning signal. This allows time for the fleets to clearly separate and means that the warning signal will be displayed after the X (if any) is removed, avoiding confusion to the sailors.

If, for any reason, there is a long delay between same series starts, AP should be displayed and the orange starting line flag(s) removed

The Preparatory signal consists of just one flag and one sound signal, i.e. the P flag, however, if one of the Starting penalties outlined in RRS 30 or the Sailing Instructions shall apply for that start, the respective flag signal to indicate the relevant penalty (flag I for 'round-the-ends', flag Z for a percentage penalty, flags I + Z for both, flag U for the “soft Black Flag” or Black flag for the Black flag rule) replaces flag P. Only one flag has to be displayed, meaning a Preparatory with or without a specified starting penalty to be in force.

M.2 The starting procedure

The functions to be performed at each start are: Race Officer, Gunner, Signals Officer, Timekeeper, and Recorder. However, the number of personnel performing those functions

may vary depending of some factors as number of starting boats, number of starts, speed of boats, etc. (see also Section A, Chapter 2.3).

It should be remembered that the visual signals govern, and they must therefore be displayed and removed with precision.

Although the failure (absence) of a sound signal shall be disregarded (RRS 26.1), the mistiming of a sound signal during the starting procedure is in fact an error of the Race Committee that has no rule that says it may be disregarded. If the mistiming is such that it could result in boats being misled resulting in OCS or perhaps a claim for a late start request for redress, then it would be prudent for the race to be postponed if time permits, or abandoned and restarted.

M.2.1 Guide of actions during the starting procedure.

This guide begins 15 minutes before the start:

Start, -15:

RACE OFFICER: Continues to check wind direction and velocity, lays the starting line and checks its accuracy. Receives radio reports from RC boats around the course on wind strength and direction. Checks that the team members are all on station and ready.

RECORDER: Continues to record the competitors as they comply with any Sailing Instruction regarding reporting, and notes in a diary any readings or comments supplied by the Race Officer.

SIGNALS OFFICER: Has the course signal indicating port or starboard rounding displayed (if applicable), and the Warning and Preparatory Signals ready. Has any other signal flags that may be required at hand, either on individual staffs or furled on halyards ready for breaking.

GUNNER: Ensures that the gun (or equivalent sound signal) is ready and the safety catch applied.

TIMEKEEPER: Gives regular time calls, for example:

"One minute to Warning Signal, prepare Class Flag, one gun";

"30 seconds to Warning Signal";

"10 seconds to Warning Signal";

"9, 8, 7,3, 2, 1, NOW!"

Start, -5:

SIGNALS: Displays Class Flag or other Warning Signal (if described in the Sailing Instructions), the signals to indicate the course (e.g. trapezoid inner or outer loop, number of laps, bearing to first mark; port or starboard rounding), other applicable signals like code flag Y (Wear personal buoyancy) or code flag S (Sail the short course described in the Sailing Instructions). Except the Warning Signal itself (e.g. Class Flag), the other signals mentioned here may be given well before, but not later than the Warning Signal (RRS 27.1).

GUNNER: Fires gun or makes alternative sound signal.

RACE OFFICER: Checks that the team are all alert and on station. Continues to receive radio messages on conditions around the course. Continues to take bearings and anemometer readings, alert to any circumstances that might make it necessary to postpone the start. Last chance to adjust the starting line by moving a starting mark (RRS 27.2).

RECORDER: Continues to check competitors in the starting area and to record announcements.

TIMEKEEPER: Continues to call time at one-minute intervals, i.e., "1 minutes to Preparatory Signal": and then a countdown as done for the Warning Signal.

Start, -4:

TIMEKEEPER: Announces Preparatory Signal.

SIGNALS: Displays code flag P, or – when one of the Starting Penalties (RRS 30) shall apply – either code flag I, code flag Z, code flags Z with I or the Black Flag. The signal to indicate one of the Starting Penalties is now the Preparatory Signal (RRS 30.1; 30.2; 30.3).

GUNNER: Makes the sound signal to accompany the Preparatory Signal.

RECORDER: Notes against a time entry any information relevant to the competitors or the conditions or the course.

RACE OFFICER: May start his tape recorder and speak what he observes into it for subsequent consideration. Continues with tasks listed as under the Warning Signal, but remains aware that a postponement is now required if the starting line needs adjusting.

Start, -2:

TIMEKEEPER: He starts the one-minute countdown

RACE OFFICER: Starts observing the starting line, especially if one of the Starting Penalties is in force. Establishes radio communication with the Lineboat at the pin end of the starting line.

Start, -1:

TIMEKEEPER: Announces the last minute, and begins the countdown for the start.

SIGNALS: Removes Flag P or Flag I or Flag Z or Flags Z with I or the Black Flag, if appropriate, and stands by the halyards or staffs relating to both the Warning and Preparatory Signals.

GUNNER: Makes the sound signal.

RACE OFFICER: Continues to observe the starting line, monitoring boats about to be or already "on the course side of the starting line" (OCS; RRS 2K.1). Announces (tape recorder) OCS infringements, if the I Flag Rule (RRS 30.1) is in force. Identifies boats within the triangle formed by the ends of the starting line and the first mark, if the Z Flag Rule or the Black Flag Rule is in force.

RECORDER: Notes any boats about to infringe RRS 2K.1 (OCS) or boats that infringe a Starting Penalty by carefully listening to the announcements of the RACE OFFICER.

Start:

TIMEKEEPER: Having given the countdown, the timekeeper calls the start.

SIGNALS: Removes the flags appropriate to the start, and displays the Warning Signal for the next class, if appropriate.

GUNNER: Makes the sound signal for the start and stands by for any subsequent sound signals such as may be required for an Individual or General Recall.

RACE OFFICER: Sights the line to determine whether to:

- pronounce a clear start;
- call an Individual Recall for any identified boats on the course side of the starting line; or
- order a General Recall.

This decision has to be made very rapidly and for consultation, the Race Officer should be in radio contact with his Lineboat at the time of the start.

Start, +:

SIGNALS: If appropriate, displays code flag X for an Individual Recall until all boats have complied with RRS 2K.1 or RRS 30.1 (if it applies), but not later than 4 minutes after the Starting Signal or one minute before any later Starting Signal, whichever is earlier (RRS 2K.2); or he displays First Substitute for a General Recall and waits for the RACE OFFICER to announce the next starting procedure; or he prepares to display the Preparatory Signal for the next class; or he stows all signals away except those identifying the Starting vessel as "on station".

RECORDER: The sail numbers of any OCS boats or of boats having infringed the Z Flag Rule or the Black Flag Rule must be checked against the entry list and passed on to the Finishing Vessel to go into the results. If boats have been identified by their hull, crew or equipment rather than by their sail number, the Race Committee has to find out which sail numbers belong to each of these boats. It has to make sure that no error might have occurred in identifying those boats.

In case of a General Recall under the Black Flag Rule or in case the race is abandoned, the sail numbers of any boats being disqualified due to this rule must also be quickly checked against the entry list and then displayed from the Starting vessel (or Signal boat) on a whiteboard, so that all competitors can check it before the next Preparatory Signal (or the next Warning Signal) is given.

The RECORDER also records the starting time, checks starters against entries and confers with shore base for missing competitors. Organizes the recorded notes taken during the starting procedure.

TIMEKEEPER: If there are no Recalls or other classes to start, he relaxes from intense concentration which accuracy demands. If there is an X flag up, he will indicate when 4 minutes have passed since the start (or indicate one minute before any later Starting Signal, if this is earlier). If there is a General Recall, he will let the Race Officer know when the next five-minute sequence starts, so that the next starting procedure can be begun. If there is another class to start, he will do the usual countdown towards the Preparatory Signal, etc.

RACE OFFICER: In case of an Individual Recall, he will watch for the OCS boats to return and start correctly, keeping radio contact with his Line boat. In case of a General Recall, he will start a new sequence as soon as possible, but may need to let one five-minute interval pass to adjust the starting line. If another class is to start, he also has time until the Preparatory Signal to make any line adjustments. After the start he begins race surveillance, in particular looking for wind variation and strength which may require a course change, or lead to competitors having difficulty.

During a start sequence with O flag displayed as per Appendix P5, the wind may become less than the specified limit after that flag has been displayed. Under that circumstance, instead of a R flag as provided by Appendix P5 (c), a better race management procedure at that situation would be consider a postponement to give sailors a more fair start without O flag.

M.2.2 Sighting the line

This is more difficult than it seems. A lot depends upon what is used for the mast or pole on the committee boat that forms the starboard end of the start line and how much room there is on the committee boat.

A yacht as a committee boat

If a yacht is used as the committee boat it will have a tall mast. The taller the mast the thicker it is at the bottom. To judge the line accurately it is recommended that the Race Officer takes up a position one metre away from the mast with the leading edge of the mast in line with the pin end. On some boats it is not possible to achieve this position safely.

The next best position is for the Race Officer to stand forward of the mast with his left shoulder firmly against the mast. This places his eyes some 30 cm on the upwind side of the start line. Therefore any boat that is sighted over the line is most definitely over!

The final position on a yacht, is to stand looking at the pin end with your head firmly resting on the mast behind you.

The latter two positions have the advantage that there is an unobstructed view of the whole start line and the boats making their approach to the start.

Have a second person sighting the line

A motor launch as a committee boat

This type of boat usually has a temporary mast fixed to the guardrail. Standing one metre away and sighting on the pin end is therefore quite practical. Because the pole is usually much thinner than a yachts mast, it does not obstruct the view of the Race Officer in the same way.

The Pin end

When a boat is used as the pin end then the positions described above apply at that end of the line.

When a buoy is used then the person sighting the line has to anchor his boat on the extension of the start line, lining the Pin end buoy with the mast on the committee boat.

When anchoring he must leave sufficient room between his boat and the buoy so that a boat may pass between the Pin end boat and the Pin end buoy when flag I has been displayed.

Another pair of eyes

Always have a second pair of eyes on each end of the start line. This will help in the correct identification of the boats. No less than four line sighters (two at each end), including the Race Officer shall sight the line at major events.

M.2.3 Communication with the pin end

The Race Officer has to make an instant decision at the Start signal. He has one of three choices to make;

- It is a good start – ‘Line Clear’
- There are one or more clearly identified OCS boats – ‘Flag X, Individual Recall’
- There are too many unidentified boats – ‘1st Sub, General Recall’

To assist him in the decision making process he requires information from other race committee members sighting the line, in particular the Assistant Race Officer at the Pin end.

A good system is for the Race Officer to be silent at the moment of the start, enabling the line boat to talk. The Race Officer can then compare this information to his own observations and immediately make the call.

At this stage the Race Officer does not require boat sail numbers. The information he requires is:

- How many boats identified?
- How many boats in total over the line?

Once this information is transmitted to him as two numbers (2 and 3); two boats identified, three boats over in total. The first number is always the number of identified boats, the second number is the total number of boats over the line. The second number can never be less than the first number!

This information, added to his own observations, allows him to decide between an Individual Recall and a General Recall.

However, the final decision is that of the Race Officer, it is recommended that the port-end Assistant Race Officer and the signal boat Race Officer should agree the total number of identified OCS (or BFD) boats and the total number considered OCS (or BFD) - the policy used at major events.

M.3 Starting problems and solutions

M.3.1 Starting line

The starting line should be between two Race Committee boats with radio contact or between a Race Committee boat at the starboard end and a marker buoy (often called the "pin") at the port end, in which case the buoy end of the line should be supervised by a line boat, also in radio contact. For large fleets of 60 or more boats it may be desirable to have a two-part starting line with an additional Committee boat centred between the other two. This central boat must be small and preferably a rubber dinghy. Such a system in

combination with a well laid line reduces the number of unidentified boats on the course side of the starting line.

For further information on laying the starting line, please also refer to Chapter L3. For general matters on how to sight a line see Section S on Race Management Policies.

M.3.2 Line identification

The line should be identified by flags or shapes (preferably orange) as described in the Sailing Instructions. They should be attached to a staff or pole; this gives precision to the line both from the competitors' point of view from the water and that of the Race Officer who will be sighting along it.

M.3.3 Floating lines

As with all marker ground tackle, anchor lines should be weighted a few metres below the surface to prevent boats from fouling them.

M.3.4 Line adjustment

Up to the Preparatory Signal (see RRS 27.2), changes to the starting line must be possible at short notice. Timely adjustments correcting the line for wind shifts and/or tide can make the difference between a perfect start and a General Recall.

M.3.5 Delays

Starts should not be delayed unless conditions are unsuitable. There should not be a delay because competitors are late unless the late arrival is due to an action or omission of the Race Committee such as a postponement signal ashore, unforeseen launching problems reported by the Beach Master, etc.

M.3.6 Boats on the course side of the starting line

The problem of boats on the course side of the starting line at (or during the minute before) her starting signal and General Recalls can be reduced by a number of practices (see also Section S on Race Management Policies):

Adjustment of the line to increase or reduce the amount of bias will help and this can be done right up to, but not after, the Preparatory signal. Good radio contact between Race Committee boats will help as will the prompt calling of boats over the line. Individual recalls should be made promptly after the Starting Signal in order to demonstrate the Race Committee's intention to detect premature starters and provide a good, fair start.

Events with large fleets are regularly plagued by the problem of "premature starters" and General Recalls. Some Race Officers feel that a General Recall should always be signalled unless all boats on the course side can be identified. There is no rule requiring this; in fact, the contrary is true.

RRS 29.2, General Recall, states:

When at the Starting Signal several unidentified boats are on the course side of the starting line or there has been an error in the starting procedure, the Race Committee may signal a General Recall.

The Race Officer must weigh up the pros and cons of allowing perhaps one or two offenders to escape against the penalty that a General Recall may impose upon a large number of competitors who made a good start. Every effort should be made to identify at least the principal offenders and to apply the Individual Recall procedure to them. By identifying most boats on the course side and using an Individual Recall signal to bring them back, a salutary lesson is conveyed to the fleet and, at the same time, those starting correctly are rewarded.

I Flag Rule

Troublesome fleets can be brought into line by applying RRS 30.1 - the I Flag Rule (former also called "Round-the-Ends" Rule) - either to all starts or after the first start. However, this penalty is generally not favoured by competitors and Race Committees. Especially when there is a large fleet, it provides grossly disproportionate penalties depending upon where a boat is on the starting line.

Black Flag Rule

A rather drastic penalty is the Black Flag Rule (RRS 30.3) which provides for disqualification (without a hearing) of any boat being identified within the triangle formed by the ends of the starting line and the first mark during the minute before her starting signal. If the race is restarted, resailed or rescheduled, those boats are not entitled to compete and have to leave the racing area during that race. And if a General Recall is signaled or the race is abandoned, the Race Committee shall display the sail number of any boat disqualified under this rule.

However, this penalty should remain as 'a last resort' for a Race Officer to communicate with the fleet, and its use is only recommended after every effort to use individual recalls has been unsuccessful. The most unfavorable situation would be a series of consecutive General Recalls under the Black Flag Rule, which would turn into cutting the fleet down into a small group that is still entitled to compete in that race.

Z Flag Rule

The restrictions for boats are the same as with the Black Flag Rule but if a boat breaks the Z flag rule (RRS 30.2) and is identified, her penalty will be a scoring penalty of 20%, i.e. (calculated as stated in RRS 44.3 (c)) the boat will be given a score worse than her actual finishing place by the number of places nearest to 20% of the number of boats entered. However, the boat shall not be scored worse than Did Not Finish. If the race is restarted, resailed or rescheduled, the penalty shall still be given.

Example: 54 boats had entered in a regatta; 20% of 54 boats is 10.8, rounded to the nearest whole number results in 11. So 11 places will be the 20% scoring penalty for all races in this regatta. If a boat is then identified infringing the Z Flag Rule in a race, and this boat actually finishes place 17, she will be given a score of $17 + 11 = 28$ in the results' list for that race.

Note: if boats infringe the Z Flag Rule, but there is no General Recall, those boats will receive an Individual Recall and will be treated under RRS 29.1 and RRS 30.2. So boats deliberately starting early will have no advantage except that they might interfere with other competitors heading for a good start. See also Section D, Chapter 15.3.7.

U Flag

Appendix L of the RRS introduces in 2013 the U flag system (RRS L11.5), which has been used by the Laser class for a number of years. The U flag system can be interpreted as a mild version of the Black Flag Rule (RRS 30.3). When the U flag is displayed as the preparatory signal, the restrictions for boats are the same as with the Black Flag Rule but if a boat breaks this rule and is identified, she shall be disqualified without a hearing but not if the race is restarted or resailed or postponed or abandoned before the starting signal.

M.3.7 Miscellaneous problems

Other problems include setting a starting line in light conditions with strong currents, particularly upwind currents (see Section L, Chapter 7). Similarly, very deep-water, limited visibility, or light and extremely variable winds, etc. can all be trying conditions for the Race Officer as well as the competitors. Careful preparation and selection of equipment may help with some of these, but others may call for postponement.

The Race Officer may avoid some of the frustration among competitors by using code flag L and informing competitors as to the nature of the problem. Generally the well-prepared Race Committee directed by a thoughtful and level-headed Race Officer will find solutions to all problems.

M.4 The Gate Start

M.4.1 General

Classes expecting a large number of entries sometimes use "Gate" Starts. These can reduce the problem than of the line bulging and the resulting General Recalls, which often occur with the very long starting lines required for large numbers. Gate Starts are also used offshore when high waves or difficult anchoring for marker buoys make it desirable. Although not always an easy answer to starting problems, it is a recognized technique in race management. However, the Gate Start can create far more problems than a conventional start if used without a good understanding of the procedure

M.4.2 Procedure

1. The fixed starting line is replaced by:
 - a free-floating port-end mark; and
 - a guarded "Pathfinder" boat, which sails away from this mark on a port tack, thus creating a steadily opening gap (the "Gate") between the mark and the Pathfinder boat.
2. All boats pass through the Gate on starboard tack, choosing their own time for leaving the Gate. In ideal conditions, if all boats sail at the same speed as the Pathfinder, a boat leaving the Gate just after it has been opened, should have no advantage over a boat that passes through the Gate close behind the Pathfinder, five minutes or so later.
3. To annul tidal effects, the port-end mark is usually a free-floating mark.
4. To protect the Pathfinder's stern, a Gate Launch traveling close astern acts as an extension of the Pathfinder and represents the starboard end of the Gate. The free-floating mark is usually dropped by this Gate Launch just before the Starting Signal.
5. The Race Committee Official on board the Gate Launch can release the Pathfinder after most boats have started. The Gate Launch then continues at the same speed and on the same compass bearing, to allow the remainder of the fleet to start.

6. A separate Guard Launch, if used, travelling on the starboard side of the Pathfinder, gives additional protection to leeward.
7. While under the control of the Gate Launch, the Pathfinder has right-of-way over all other boats.
8. It is general practice to select as Pathfinder the boat that finished 10th in the previous race. For the first race, the Pathfinder is usually determined either by the Practice Race results, or by draw from among the boats likely to finish in the top 25% overall. It is usual to exempt a boat from further duties as Pathfinder once it has performed them, and to take the next boat in order.

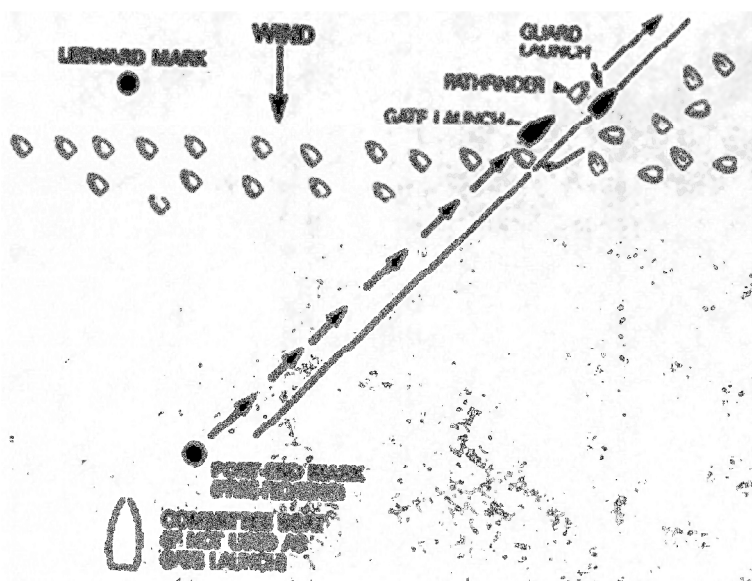

Illustration of a Gate Start, with free-floating port-end mark, Pathfinder and two Launches.

M.4.3 Operation

1. Code flag G is displayed to indicate a Gate Start.
2. The Committee boat, the Gate and Guard Launches, and the Pathfinder, station themselves some distance directly to leeward of the leeward mark. The distance below the mark contributes to the length of the first beat of the race and may vary from nil to half a mile. The Gate Launch may also be the Committee boat, in which case, two launches do the work of the three in the diagram (see above).
3. All signals are given from the Gate Launch and may be repeated by the Committee boat.
4. Fifteen seconds before the starting time the Pathfinder, on a pre-arranged signal, begins a close-hauled port-tack course with the Gate Launch following between one and three boat lengths astern. The Guard Launch steers a parallel course to the Pathfinder at 45° off her starboard bow and at a distance apart so that her wash does not interfere with the Pathfinder.
5. Three seconds before the starting signal, a free-floating mark is dropped from the starboard quarter of the Gate Launch. Boats may start on starboard tack after the starting signal, passing between the free-floating mark and the stern of the Gate Launch.

6. When the Race Officer on board the Gate Launch is satisfied that he has the speed and compass bearing of the Pathfinder's port tack, that the wind is steady and that most of the fleet has started, he may, by hail, release the Pathfinder which may then tack on to starboard or continue on port, as she wishes. After being released, the Pathfinder no longer has any right-of-way on port tack (see paragraph K.4.2, item 7).
7. At his discretion, the Race Officer will, subject to the Sailing Instructions, stop the Gate Launch, drift for an allowed time, and then close the Gate by removing code flag G. No boats may subsequently start

M.4.4 Natural Conditions Required

For the Pathfinder to sail a course that will result in a fair Gate Start the wind must be:

- steady in direction. A 5-10° oscillation could be acceptable if the period of the oscillations is reasonably constant and predictable during the start;
- between 2 and 6 Bft (4-27 knots) in strength. A Pathfinder having to search for wind or fight for survival is no good to the Race Officer or the fleet.

The sea conditions must also be:

- such that the Pathfinder can sail a true course at a constant speed without having "to play the waves" for safety, although it should be remembered that some classes preferring open water to harbour water may, when there is a good sea running, best be sent on their way with a Gate Start;
- non-tidal or with a tidal stream of constant rate and direction in the starting area.

M.4.5 Equipment

1. If a Committee Boat is used, it will require the starting equipment to meet the normal procedure for starting as outlined in RRS 26 or such modification of it as the Sailing Instructions may require (e.g. RRS L 11.1). As indicated above, the Gate Launch may be the Committee boat or it may duplicate the signals of a separate Committee boat.
2. The Gate Launch must be large enough to accommodate the Race Officials together with the normal operating crew and have aboard starting equipment, a free-floating mark, a signal mast and flags. A good size for such a vessel is between 6 and 8 metres. If it is any larger, the Pathfinder may obtain too great an advantage when it is released.
3. The Gate Launch should be capable of maintaining a true course (with an accurate and easily read compass) astern of the Pathfinder at all speeds over 3 knots, should not tend to drift off course, and be capable of doing 12 knots. It should have an effective fender all around the boat.
4. The Gate Launch and the Guard Launch helmsmen must be competent and able to maintain a constant position astern or starboard of the Pathfinder.
5. The Guard Launch must be large enough to provide protection for the Pathfinder and be of similar capability in terms of speed and manoeuvrability.
6. The Guard Launch should have a mast of sufficient height to enable competitors to see her distinguishing flag and note her position.
7. The free-floating mark should be large and bright to be seen in the prevailing conditions.

M.4.6 Other considerations

A Gate Start is subject to a General Recall just like a conventional start. It may be signalled when the Race Officer considers the start to have been unfair, or when the Pathfinder, the Gate Launch or the Guard Launch is interfered with by boats in such a way that the operation of the Gate is impeded. The usual cause of a General Recall is a wind shift sufficient to favour one end of the line.

Interference with the Pathfinder may lead to disqualification of the competitor concerned and this must be made clear in the Sailing Instructions and at the briefing.

A Gate Start should allow all competitors of all standards an equal start but its smooth operation depends, for its success, on the skills of the Race Committee, the courage and skill of the Pathfinder, some competitors experienced in Gate Starts and the dependability of the Gate and Guard Launches. An attempt to use a Gate Start without these qualities is likely to end in failure.



ISAF RACE MANAGEMENT MANUAL

SECTION N

During the Race

Contents

Page

N	During the Race	
N.1	Fleet Surveillance	N 2
N.2	Course Changes	N 2

Monitoring the fleet and observing the weather conditions are major tasks of the Race Committee during the race. The Race Officer has to ensure fair conditions for the competitors and therefore has to consider changes of the course or even abandonment, when major wind shifts occur or the security of the competitors is in question.

N.1 Fleet surveillance

With racing under way, there is still little time for the Race Committee to relax. The wind must be constantly checked for variation. Abandonment and re-sail may have to be considered if there is a major wind change during the first leg, or when conditions are extremely heavy, in which case safety factors require that the fleet be under constant observation.

The Race Officer will want to ensure that the Patrol teams are strategically placed to deal with emergencies. In case of little wind, close observation is also necessary: many classes have Championship Rules defining the maximum time allowed for a leg or a lap, or the minimum wind or boat speed required, so there may be time limits to consider.

Information on wind strength and direction should come in or be sought from the RC boats around the course. The position of the leading competitors should be known at all times in case decisions have to be made regarding a course change.

The recording of mark roundings, of 360° or 720° penalty turns and of protest flags seen all comprise useful intelligence which should be recorded. Mark boats should all have a list of entrants and then be advised by the start boat the number of actual starters, mark rounding records can then be reconciled with the list of starters as the last boats round the mark, any boats not recorded should then be accounted for. Retirement sheets should be available on shore for signing by boats that retire as soon as they come ashore.

For more on Abandonment, see RRS 32 & Section S Chapter 11 (Race Management Policies). No specific guidelines can be given as to when to abandon and re-sail a race and when to continue. Any decision on this matter should be made considering the "pros and cons" for each competitor. The ability to know when to do it and when not to is one of the means by which a Race Committee can prove its skill and experience. It is up to the Race Officer to make this decision based on his experience and the information he receives from his fellow Race Committee members around the course but only as a last resort after considering all other options such as altering or shortening the course. Once a race has started every effort should be made to achieve a finish.

N.2 Course changes

If the reports the Race Officer receives from the various boats around the course (particularly the one on the windward side of the course) indicate that the wind is shifting on a permanent basis and that the new wind direction is likely to prevail for at least the duration of the next windward leg, he may decide to move the windward mark. Other marks, too, may be moved to restore the shape of the course. How marks are to be moved and how this is to be signaled to the sailors can be found in Section B, Chapter 8.7 (Adjusting a course for wind changes).

Whether or not the course is to be changed will depend on a variety of considerations. The leading one must always be that the course change will result in the race becoming fairer. Changing the course in a long race will be more effective than a change in a short race. If races are short, there will usually be more races to follow and it might prove better to leave the course for the moment and set a better one for the next race.

Whether there is an opportunity to change a course will also depend on the number of classes sailing on the course at the same time, the spread of the boats around the course and — equally importantly — the local conditions and the skills of the Race Committee. It has to handle the process in such a way that there will never be any confusion for the competitors. It is far better to keep going on a poor course and consider shortening the course at a mark (make sure that the class or championship rules allow races to be shortened) than to mess up a race because some boats believe they must go to mark X while the rest of the fleet are heading for mark Y.

As in the case of abandonment, the ability to change the course — and knowing when to do it and when not to — is a typical Race Officer skill. It is up to him to decide, on the basis of his experience and the information received from the other Race Committee members. See also Section S, Chapter 11



ISAF RACE MANAGEMENT MANUAL

SECTION O

The Finish

Contents

Page

O The Finish

O 1	Types of finishing line	O 2
O 2	Laying the finishing line	O 3
O 3	Preparatory tasks	O 4
O 4	Finishing procedure	O 4

Various kinds of finishing line used on different course types are described. Emphasis is made on how to lay a finishing line: it should be at right angles to the direction of the course from the last mark, and it should be relatively short (12-15 boat lengths). The major jobs of the Finishing team are mentioned as well as some further aspects of the Finishing procedure.

With the race two-thirds completed and at the discretion of the Race Officer, who will want to allow time for any problems he may meet in setting the finishing line, the Starting vessel, or a separate Finishing vessel, moves to the location of the finishing line. A separate Finishing vessel is particularly useful if another start is scheduled, as it allows the Starting vessel to remain on station and begin the next starting sequence as soon as the fleet has returned to the Starting area. See also Section S, Chapter 2.

O.1 Types of finishing line

There are various kinds of finishing line:

Type 1 – Mark / Finishing vessel

A line consisting of a Mark of the course at the port end and the Finishing vessel at the starboard end. For an old-style Olympic course this will usually be Mark 1, i.e. the race ends with a beat. However, with a shortened course, it is also possible to finish at Mark 3. The important thing is to ensure that the boats will automatically cross the finishing line when rounding the mark (this is for a port hand course).

This type of finish is appropriate when there is only one class and its ability is reasonably uniform, with no boat being more than one lap ahead of any other.

Type 2 – Separate line / upwind or downwind

A separate finishing line approximately 0.1 to 0.2 NM (or less) to windward of Mark 1, the race ending again upwind with a beat, or approximately 0.2 NM (or less) to leeward of Mark 3, the race ending downwind with a run. The advantage is that any boat that still needs to round the mark (e.g. when there is more than one class on the course) can do so without being hindered by boats finishing.

This type of finish is used where there are several classes competing on the same Race area, with reasonable fleets of up to 60-70 boats; and for one-class races with a large fleet and mixed ability.

Type 3 – Separate line / reaching leg

A separate finishing line at the end of a close reaching leg, between a separate Finishing vessel port-hand and a nearby starboard mark. The finishing line must be at right angles to the direction from the last mark.

This type of finish is used for the Trapezoid Inner and Trapezoid Outer Course (no upwind finish). For the position of the Finishing vessel, see Section L.

Type 4 – Land mark / buoy

A typical long-distance course finish is one where boats have to cross the imaginary line between the Finish buoy and a mast ashore, in the direction of the course from the last mark, regardless of wind direction.

This type of finish is also used for the slalom (Ins & Outs) finish of the Funboard class. An alternative is to finish on shore between two masts, but this may damage the boards' fins. A solution would be to arrange for the masts to be planted in the water just outside fin depth.

Whatever type of finish is used, for large fleets and/or close finishes it is recommended to have a Line boat at the port end of the finishing line, with an extra recording team.

O.2 Laying the finishing line

If there is an assisting RC boat, the Finishing vessel may anchor in approximately the right position and then ask the other RC boat to lay the Finishing Mark, following the same procedure as that for the pin end of the starting line.

If the Finishing vessel is on its own, or if Mark 1 is to become the pin end of the line, the Finishing vessel will stop 50 to 100 m to starboard of the mark or the Finishing Buoy it has just laid itself; it will anchor a short distance ahead and then fall back so that the line between its staff and Mark 1 (or the Finishing buoy) is at a 90 degree angle to the last leg (port hand course).

There is a common misunderstanding that the finishing line is set at a 90 degree angle to the wind. The definition according to RRS Definitions, of the term "Finish" is:

"A boat finishes when any part of her hull, or crew or equipment in normal position, crosses the finishing line in the direction of the course from the last mark either for the first time or, if she takes a penalty, after complying with rule 31.2 or rule 44.2. or under rule 28.1 after correcting an error made at the finishing line."

In other words, if for any reason it has not been possible to adjust the course, or on the last leg of the course there has been a change in the wind direction, the finishing line should be placed in accordance with the direction of the course from the last mark, that is, at 90° to the course from the last mark and not at 90° to the wind.

This is in fact what happens on the new Trapezoid courses. For a full description of the relevant finishing line, see Section L,

In deep water one must consider the effect of this criterion, especially with variable winds; for example in the case of a wind shift greater than 15°, both the Mark/Finishing buoy and the Finishing vessel will logically rotate around their respective anchors by the same angle (see figure). They will move to positions 2, but in order to maintain the original orientation one should let out line so that the final boat position becomes 2'. The result is that a line whose original length was 12 boat lengths has been reduced to 10 boat lengths.

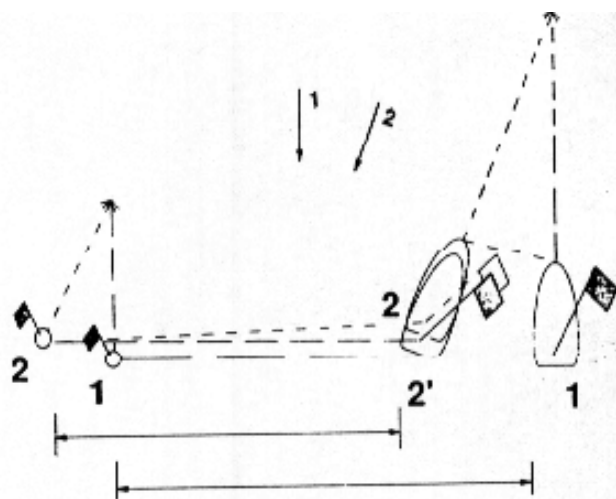

The finishing line should be relatively short: 12-15 boat lengths, depending on the fleet size, the type of boats competing and the weather conditions. A short finishing line may decrease the chance of massive group finishes; it significantly reduces the margin of error and

therefore reduces the possible advantages that may be created by the movement of either end of the line.

O.3 Preparatory tasks

With the "On station" signal (a blue flag; see RRS Race Signals) together with any other flag called for in the Sailing Instructions (e.g. to indicate another start) aloft, the Finishing vessel team prepares itself, noting the approach of the leading competitors and ensuring that they are not caught unawares by a boat suddenly appearing from under their stern.

The Race Officer or his delegate gets ready to call the sail numbers, sighting the course side of the staff on board the Finishing vessel and the course side of the pin end mark. Many Race Officers use a tape recorder as a useful back-up.

The Recorder prepares to record placings and times and the back-up Recorder gets ready to note the finishing order without concerning himself with the times. It is usually not necessary to record every finisher's time (unless it is handicap racing), but it is good practice to write down the time against the sail number of every fifth or tenth boat finishing.

The Recorder will also check whether or not the number of boats finishing corresponds with the number that have started. Any discrepancies will have to be accounted for. For safety reasons, boats having started in a race but then not finishing (e.g. retiring) or not returning to the harbour should report to the Race Committee on the water or ashore, as soon as possible. This will avoid search and rescue operations.

The Recorders' sheets will be the data for the Results' team or the Race Office secretary back at shore base. They will be referred to when any boats want to clear their finishing position, or request redress when e.g. a wrong or no finishing position is published in the Results' list.

One team member may prepare to look solely for any protest flags flying and to take down protestees' sail numbers called by protesting boats.

O.4 Finishing procedure

Abstract

Finish A boat finishes when any part of her hull, or crew or equipment in normal position, crosses the finishing line from the course side. However she has not finished if after crossing the finishing line she

- (a) takes a penalty under rule 44.2*
- (b) corrects an error under rule 28.2 made at the line, or*
- (c) continues to sail the course*

It is not expected of the race committee to follow the actions of every boat, especially in a race with a big number of boats. The finish boat crew should record every boat that crosses the line from the course side. Possible double recordings of boats can be solved later.

The instant the first boat finishes, sound a clearly recognizable signal (e.g. a loud sound signal), so that the other competitors have a time reference to the first finish; record the hour, minute and seconds, and calculate the time limit.

The finish of the subsequent boats may be accompanied by a different sound signal, such as a whistle or a horn. However, a sound signal for boats finishing is not compulsory. It is just a means of communication to the competitor ("We have noticed you crossing the finishing

line"); but a sound signal given to a boat does not necessarily mean that boat validly finishes according to the RRS Definitions. If that boat e.g. infringed the Black Flag Rule, but continues the race and then crosses the finishing line (receiving a sound signal), it still will be scored BFD (RRS 30.3 and RRS A 3).

For a handicap regatta it is vital to record the finishing times of all boats (hour, minute and seconds). In any case record the finishing time of the last boat, on which the beginning and end of Protest time will be based.

At major events there have been successful experiments to directly transmit the finishing order ashore. This is done by a small laptop computer on board the Finishing vessel connected to the results' computer ashore by a data link channel. This procedure is obviously quicker than the lengthy radio transmission by voice sometimes done after a race.

The above enables spectators and the media ashore to receive the Finishing order immediately. And the competitors, too, do not have to wait for their results until the Finishing vessel has returned to the harbour. Transmission of the handwritten finishing order by fax is also an alternative.

This transmission procedure sounds much easier than it is, as the communication software has to be suitable and the radio channels may be interfered with by other electronic fields. However, in the long run, these technical problems will be solved, giving competitors a better results' service – not only at major events.



ISAF RACE MANAGEMENT MANUAL

SECTION P

Things To Do At The End Of Each Racing Day

Contents	Page
P Things To Do At The End of Each Racing Day	
P 1 Race Committee tasks before coming ashore	P 2
P 1.1 Accounting for all starters	P 2
P 1.2 Firearm safety	P 2
P 1.3 Advising essential particulars	P 2
P 1.4 Advising full results	P 2
P 1.5 Lifting marks	P 3
P 1.6 Dismissing auxiliary vessels	P 3
P 1.7 Advising auxiliary services	P 3
P 2 Race Committee tasks after coming ashore	P 3
P 2.1 Firearm safety	P 3
P 2.2 Special notices	P 3
P 2.3 Official results	P 3
P 2.4 Collecting race records	P 4
P 2.5 Initiating protest sequence	P 4
P 2.6 Protests from the Race Committee	P 4
P 3 Evaluation of performance	P 4

The topics in this chapter are in their approximate chronological order. Race Committee tasks before and after coming ashore are specified, as checking provisional results lists, collecting race observations and dismissing auxiliary vessels. The Race Officer will not necessarily perform all these duties himself, depending on the experience and reliability of his Race Committee. The duties described here are normally the direct responsibility of the Race Officer or a member of the Race Committee in direct contact with him. Finally, after a racing day, the Race Committee should discuss its own performance and possible improvement.

P.1 Race Committee tasks before coming ashore

P.1.1 Accounting for all starters

In association with Mark Boats, Patrol Boats and the Race Office, a Race Officer satisfies himself that all competitors and RC boats are accounted for. Especially in difficult conditions the "all clear" is not given until all competitors and RC boats are ashore, on moorings or at least in sheltered water

P.1.2 Firearm safety

If guns are used, after they are no longer needed on board, ensure that they are safely unloaded and stored below deck ready for cleaning.

P.1.3 Advising essential particulars

Some reporting needs to be done without delay.

- (a) If measurement checks are to be done ashore rather than on the water right after finishing, the Measurer needs to know when the boats he must check will be in. Usually it is determined beforehand which finishers 1, 3 and 5 (or any other place) will have to undergo checks.
- (b) The Race Office must know the time of the last boat to finish in order to calculate of the Protest Time limit.
- (c) If Check-Out and Check-In procedure is used for safety reasons (it must be written in the SIs) the Race Office must check if all boats complied with these procedures, not only to add the identified boat(s) a scoring penalty (if specified by the SIs), but especially to be sure that all boats have returned from the racing area. Tracking devices or tally systems can be used for safety procedures as well.
- (d) If required by the rules, a chairman of Protest Committee will appreciate the number of protest flags as seen by the Race Committee after finishing. Such information shall help in deciding validity of protest when hearing begins.

P.1.4 Advising full results

Every attempt should be made to transmit the finishing order to the Race Office as soon as possible. It will be greatly appreciated by competitors and coaches alike when a provisional finishing order, even if simply handwritten, is posted on the Notice Board (and on the regatta web page) when they return ashore.

If the finishing list to be transmitted is long, it is sensible to have short radio breaks after presenting every five or ten sail numbers, to ensure that others may interrupt in case of emergency. If there is time, ask the Race Office to read back the numbers they have taken down (see also Section S, Chapter 16)

While returning to shore, the opportunity should be taken to check the lists for any discrepancies, such as duplicated numbers or back-up lists showing a different finishing order. In the meantime, the Results Team on shore may well have calculated provisional results. If the Race Officer and his on-board Recorder are satisfied that the lists are correct, it simply remains to ensure that they correspond with provisional results waiting ashore.

P.1.5 Lifting marks

Usually the Course Setter will want to pick up the marks himself to be prepared for the next racing day. If, for expediency, there are several lifting marks boats, instructions should be given as to where the marks should be assembled so that the Course Setter can immediately collect them to avoid having to search for them the next day.

P.1.6 Dismissing auxiliary vessels

Some safety vessels may have already reported that they are leaving the racing area. It is very important, especially in open sea or heavy conditions, that fleet is sufficiently covered while returning ashore. Detailed instructions shall be given by the Race Officer.

In multiple classes event it is important that an auxiliary or RC boat stands-by at the finishing line before the leading boat in the fleet finishes the last race of the day to give instructions to the fleet in which direction shall they sail to not interfere with other courses if they are still racing.

However, when the time comes to dismiss the auxiliary vessels, it should be done positively. They should be thanked for their services to the regatta and, when appropriate, reminded of the time for the next race.

P.1.7 Advising auxiliary services

When Coast Guard, Harbour Board, Life Boat or such services have been on standby, it is common courtesy to sign them off with an expression of appreciation.

P.2 Race Committee tasks after coming ashore

P.2.1 Firearm safety

The guns if used must be properly cleaned and prepared for the next racing day. All guns must be locked away safely overnight. If horns have been used instead of guns they may be recharged for the next day racing day.

P.2.2 Special notices

The result form will be the official source of information and, in terms of the rules, is all that is required. However notifications on the Official Notice Board related to OCS, BFD, ZFP or other disqualifications will be a desirable courtesy to competitors giving them ample time to consider any request for redress.

If the Race Committee intends to protest a boat after an incident observed in the racing area, it shall inform the boat before the protest time limit, as required by RRS 61.1(b). The easiest way to do it is with posting notice on the Official Notice Board.

P.2.3 Official results

Any results posted before the Protest Time expires are provisional. If no protests are lodged within the stated time, the results will then become official. However there are still circumstances under in terms of RRS 61.3, 64 and 66.

Details on how to deal with protests can be found in RRS Part 5 (Protests, Redress, Hearings, Misconduct and Appeals), RRS Appendix M (Recommendations for Protest Committees) and RRS Appendix N (International Juries), Section P, Chapter 2.5 and 2.6 of this Manual and in the ISAF Judges Manual.

Media often require results to be given as soon as possible, even provisional for their news items. The Press Officer should make sure that they are supplied with results and any other information, expressing however their "provisional" nature.

For more details on scoring, see RRS Appendix A (Scoring).

P.2.4 Collecting race records

It is good practice for all auxiliary vessels to log all observations during each race. The Race Officer needs to have any race observations that have been recorded: mark roundings, starts and finishes, retired boat, penalty turns observed any contacts between boats which might call for action under RRS 14 and other observations which have been logged on auxiliary vessels. All records should be kept in the Race Office, as they may be required by the Race Officer or the Protest Committee after the race.

P.2.5 Initiating protest sequence

The procedure stated in the Sailing Instructions regarding the Protest Time limit will have been initiated by the Race Office before the Race Committee comes ashore. As the person responsible for "his" course, the Race Officer needs to check that these actions have been properly taken.

P.2.6 Protests from the Race Committee

Since sailing is self-policing sport and primary responsibility for protesting breaches of the rules stays with competitors, the Race Officer will not normally protest a competitor. But the Race Committee will, as required by rule 60.2, protest a competitor when it receives a report from the event Measurer required by rules 43.1(c) or 78.3. The Race Committee may protest a competitor in the following circumstances:

- (a) a breach of a Sailing Instruction that may not be protested by another competitor;
- (b) an apparent breach of good sportsmanship (rule 2);
- (c) failing to take a penalty after knowingly touching a mark, but not protesting another competitor;
- (d) failing to sail the course (rule 28).

P.3 Evaluation of performance

The answers to the question "How well did we do?" may come from the Race Committee itself or from the competitors. Both the Regatta Organizing Committee and the Race Committee should discuss their own performance and how it might be improved.

The opinions of the competitors are well worth considering, keeping in mind however, that those who have done well will almost certainly think that the organization was good, whereas those who are disappointed in their performance will only be looking for any excuse and the Race Committee is the likely target.

However the conscientious Race Officer should appreciate that no matter of experience, his performance will often be capable of some improvement and competitors may well present some useful comments.



ISAF RACE MANAGEMENT MANUAL

SECTION Q

Things To Do At The End Of The Regatta

Contents

Page

Q	Things To Do At The End Of The Regatta	
Q 1	The final results	Q 2
Q 2	Prize-giving ceremony	Q 2

At the end of a regatta the final results have to be calculated in accordance with the scoring system that shall apply. Then, careful planning is necessary to properly award the winners during a prize-giving ceremony which fits in with the character of the event. Some hints are given below how to make this ceremony a dignified and memorable conclusion of the regatta.

Q.1 The final results

The final results have to be calculated in accordance with the scoring system described in the Sailing Instructions, which is usually the Low Point Scoring System, as described in RRS Appendix A.

This process is usually taken by the Results Team who uses one of the scoring programs that are available either in internet or within organizers possession. Things to be remembered: identifying the worst scores, deducting the appropriate number of points, applying the procedure for tie-breaking and then allocating the final places. See RRS Appendix A

Once the Race Officer has checked the scoring, all abbreviations, series ties, results of last protest hearing or any request for redress he may consider his task completed.

Q.2 Prize-giving ceremony

The prize-giving is usually associated with major social function of the regatta, often a formal dinner. Organizing of this is Social Committee responsibility (see Section F, Chapter 10). The prize-giving ceremony itself requires careful planning to ensure appropriate dignity and a memorable conclusion to the regatta. The prizes should be set out on a decorated table and in order in which the presentation is to take place.

There will often be a number of speeches whose length should be kept to a minimum. They might include the Commodore of the Host Club, the Race Officer or Regatta Chairman, who may wish to acknowledge the contribution of his team and the sportsmanship of the competitors.

The highest ranking official of the Class Association on whose behalf the regatta has been conducted, and a local dignitary such as the Mayor of the town will also want to speak. There may be further brief speeches from the principal winners (winner only or top three). It is recommended to brief speakers as to the time they have been granted.

The first awards may be expressions of appreciation to various people. Following those, as a general principle, the most commonplace awards should be presented such as mementos that are given to all competitors. These might be followed by intermission with some "fun" awards (furthest travelled; most capsizes; sprint prize). Heat prizes might follow and then the overall prizes. Next might be special prizes such as the top-placed junior, the top-placed lady or veteran, and then last but not least, the overall regatta winners in ascending order so that the final prize is the climax of the evening.

It is so easy to spoil the ceremony by drawing it out unnecessarily, giving wrong prizes to recipients and searching names and inscriptions. The person calling the competitors forward to collect their prizes should ensure their correct names, and pronunciation. Except in the case of single handers, never mention or call the helmsmen only and always make sure that the crew is prized the same as the helmsmen.

The top prize should end the proceedings except for the briefest of farewells and extending good wishes for a safe return home.



ISAF RACE MANAGEMENT MANUAL

SECTION R

Post Regatta Tasks

Contents

Page

R Post Regatta Tasks

R 1	Logistics	R 2
R 1.1	Transport	R 2
R 1.2	Removal of signs	R 2
R 1.3	Return of equipment	R 2
R 2	Administration	R 2
R 2.1	Formal report	R 2
R 2.2	Letters of thanks	R 2
R 2.3	Finance	R 2
R 2.4	Final evaluation	R 3

There are still a number of important matters to be attended to once the prizes have been awarded. They are in the hands of the Regatta Organizing Committee or their delegates, e.g. transport assistance to competitors and visiting officials, return of equipment and balancing the books. A final evaluation report will be appreciated as support for future events.

R.1 Logistics

R.1.1 Transport

If competitors, protest committee members, etc., were enthusiastically assisted on arrival, then it is not only courteous but will leave a fine impression of the venue and the regatta if the same assistance is available to them when they depart. Especially those who have contributed with their services free of charge, and therefore often at considerable expense to themselves, should be looked after.

R.1.2 Removal of signs

Most major regattas today have sponsorship, declared by the display of banners and signs. Once the regatta is over, these should be dismantled and disposed of, by returning them to the sponsors or whatever is appropriate.

R.1.3 Return of equipment

Most major regattas borrow equipment of some kind from other Clubs and associations or from individuals. It makes good sense to make up an inventory of the borrowed equipment before the regatta. After the regatta this can then be used as a means of checking that equipment has not been lost and is ready for return to its owners in as good a condition or better than when received.

R.2 Administration

R.2.1 Formal report

In the case of a major event, a formal report is usually required for the ISAF, the National Authority, the sponsors, etc. This is the responsibility of the Regatta Chairman, who, in compiling it, will probably work closely with the Race Officer(s). The Class Association(s) may also expect a report and will wish to review the regatta and make making recommendations for the future. Copies of the results should be attached with the final report.

R.2.2 Letters of thanks

Letters of thanks will need to be written to a number of people, and they need to be written immediately after the event. In some instances they may well contain contributions towards expenses or a request for people to indicate the extent of their expenses. In this latter case, some preliminary understanding should have been arrived at around budget time.

R.2.3 Finance

When sufficient time has elapsed for all accounts to be in, but not so much that memories have dimmed and Committee members begin to apply themselves to other matters, final accounts should be approved for payment and the books balanced. Hopefully, it will be necessary to decide what will happen to the credit balance but if the worst happens, and then it may be a matter of deciding how to meet the shortfall!

R.2.4 Final evaluation

The Regatta Organizing Committee may wish to record considered views on the whole administration of the regatta, the areas of special success and any shortcomings that ought to be avoided on another occasion. Such records can be invaluable to the next Organizing Committee and contribute towards an improved standard. Such an evaluation should also be offered to the Class Association(s), which would do well to require routinely such an evaluation report for their World and Continental Championships. The Host Club, which in all probability shared responsibility as the Organizing Authority in terms of RRS 87.1, may also seek an evaluation report, so that it is also aware of its regatta strengths as well as any problem areas.



ISAF RACE MANAGEMENT MANUAL

SECTION S

Race Management Policies for the Olympic Sailing Competition and ISAF Events

Please check the ISAF website for the latest versions of the ISAF Race Management Policies

NOTE: This document will change frequently. Please check the ISAF website (www.sailing.org) for the most recent edition.

You will find it at

<http://www.sailing.org/raceofficials/eventorganizers/rm-policies.php>



ISAF RACE MANAGEMENT MANUAL

SECTION T

Race Management of Match Racing

Contents	Page
T RACE MANAGEMENT OF MATCH RACING	
T 1 Terms	T 2
T 2 Governing Documents	T 2
T 3 Organization	T 2
T 4 Competition Format	T 2
T 4.1 A choice	T 2
T 4.2 Round Robins	T 3
T 4.3 Recommended criteria for Round Robin pairing lists	T 3
T 4.4 Groups (or 'half round robins')	T 4
T 4.5 Knock-out competitions	T 4
T 4.6 Repechage	T 5
T 4.7 Tie break sail off	T 6
T 5 The Course	T 6
T 5.1 Location	T 6
T 5.2 Configuration	T 6
T 5.3 Duration	T 10
T 6 Meteorology	T 10
T 7 Equipment Failure	T 10
T 8 The start	T 11
T 8.1 The line	T 11
T 8.2 Starting Procedure	T 11
T 8.3 Requirements before the start: Rule C4.1	T 13
T 8.4 Requirements before the start: Rule C4.2	T 14
T 8.5 Individual Recalls: Rule C 3.2(a)	T 14
T 9 Postponement	T 17
T 9.1 Postponement before the starting sequence	T 17
T 9.2 Postponement during the starting sequence	T 17
T 10 Changing the next leg of the course	T 17
T 11 Shortening the Course	T 18
T 12 Abandonment	T 18
T 13 Relationships with Umpires	T 19
T 14 Match racing penalty system	T 20
T 15 Sighting the Finishing line	T 20
T 16 Scoring	T 22
T 17 Race Committee organization	T 22
T 17.1 Race Committee boat	T 22
T 17.2 Line sighting	T 24
T 17.3 Race Committee boat	T 24
T 17.4 Communications	T 24
T 17.5 The Windward Mark Layer	T 25
T 17.6 The Leeward Mark Layer	T 25
T 17.7 The Boat Master – Technical Team	T 25
T 17.8 The Crew Change Team	T 26
T 17.9 Consistency	T 26
T 18 Example of timetable	T 27

T.1 Terms

Flight: two or more matches started in the same starting sequence.

Ranking: ISAF world skippers match racing ranking (Open or Women)

Round Robin: In a round-robin series competitors are assigned to one or more groups and scheduled to sail against all other competitors in their group one or more times.

Pairing List: Starting schedules. ISAF has guidelines for pairing lists and several examples are found in the Umpires and Match Racing Manual, Section M. The pairing lists (and rule C4.1) indicate the starting side for each boat and each match and also the matches to be started in each flight. Different software's exist and organizers only need to decide the format they wish to use and then enter the competitors in the order of their ISAF ranking

T.2 Governing Documents

Rules:

- Racing Rules of Sailing
- Appendix C « Match Racing Rules»
- Notice of Race
- Sailing Instructions

Other governing documents:

- Call Book
- Case Book
- Rapid Response Calls
- ISAF Q&A's – practical advise

T.3 Organization

- An Organizing Authority
- A Principal Race Officer (can be the Race Officer)
- A Race Management team, including a Race Officer
- An Umpiring team, with a designated Chief Umpire
- A Protest Committee or a Jury, normally members of the Umpire team
- A Technical team

T.4 Competition Format

T.4.1 A choice

- When deciding on the competition format, organizers should consider all the 'players':
 - competitors
 - sponsors
 - on-the-water and on-shore spectators
 - officials, boat owners, the media, etc.
- Other constraints to be considered:
 - the weather
 - the time available
 - condition of the boats, etc.

T.4.2 Round Robins

The basis of most match racing events is the round robin. Some events consist of just a single or double round robin. Others start with a round robin and then move on to knockout competitions, usually semi-finals and finals.

The round robin is the only format in which every competitor sails against every other competitor. Each competitor sails the same number of races, and knows the minimum number of races that he will be allowed to sail when he enters the event.

If an event consists of a single round robin, it is hard to create a result that is equitable to all competitors if for any reason the round robin cannot be completed. (The Standard Sailing Instructions provides a way of having a result provided each competitor has sailed at least 1/3 of his matches, but the best solution is to complete the round robin.)

Seeding the skippers to ensure that the best-ranked skippers sail against each other at the end of the round may increase spectator appeal. In theory this would be the match between the winner and the runner-up.

The ISAF Match Race Ranking List should be used for seeding the competitors.

A critical factor is the time to compete the schedule and the time available. When planning the event, the Organizers must estimate the amount of time necessary to complete the desired programme.

The number of matches in a round robin is equal to $n(n-1)/2$, where n is the number of competitors, so a single round robin for 10 competitors would result in $10 \times 9 / 2 = 45$ matches.

- If 10 boats are available, this results in 9 flights
- Each match approximately taking 20 minutes, a flight consisting of 5 matches will require a period of 50 minutes.
- Eight or nine flights a day is a reasonable achievement.

T.4.3 Recommended criteria for Round Robin pairing lists

- (a) Principal Criteria in Order of Priority:
- (b) Each skipper sails each other skipper once.
- (c) When there is an even number of flights, each skipper has the same number of port and starboard assignments.
- (d) When there is an odd number of flights, the first half of the skippers will have one more starboard assignment.
- (e) No skipper in the last match in a flight should be in the first match of the next flight.
- (f) No skipper should have more than two consecutive port or starboard assignments.
- (g) Each skipper should be assigned to match 1, match 2, etc. in a flight as equally as possible.
- (h) In flights with five or more matches no skipper should be in the next-to-last match in a flight and then in the first match of the next flight.
- (i) If possible, a skipper should be starboard when meeting the nearest lower ranked skipper

- (j) Close ranked skippers meet in the last flight.
 - Extra criteria when boat changes are required:
- (k) Minimum number of changes.
- (l) Skippers in the last match of a flight do not change boats.
- (m) Skippers in new boats do not sail in the first match of the next flight.

(Note: k and l override f when changes are required.)

- Extra Criteria when there are more boats than matches:
- (n) Skippers have a reasonable sequence of matches and blanks.

T.4.4 Groups (or 'half round robins')

If the number of skippers is such that even a single round robin would put the event in jeopardy, the competitors may be divided into two or more groups.

With 10 skippers and 2 groups, each group now requires only $5(5-1)/2 = 10$ matches to complete their own round robin, giving 20 matches in all, less than half the full round robin total.

A disadvantage is that the skippers will not race against each of the others.

When dividing skippers into groups, event organizers must attempt to balance the groups. The following give some examples. Note that the number indicates the relative position of each competitor in the event, based on the ISAF Ranking List 30 days before the event.

Using the ranking list for seeding, the following system is recommended:

2 groups of 4 skippers		2 groups of 5 skippers		2 groups of 6 skippers		3 groups of 4 skippers			3 groups of 5 skippers			4 groups of 4 skippers			
A	B	A	B	A	B	A	B	C	A	B	C	A	B	C	D
1	2	1	2	1	2	1	2	3	1	2	3	1	2	3	4
4	3	4	3	4	3	6	5	4	6	5	4	8	7	6	5
5	6	5	6	5	6	7	8	9	7	8	9	9	10	11	12
8	7	8	7	8	7	12	11	10	12	11	10	16	15	14	13
		9	10	9	10				13	14	15				
				12	11										

When sailing in groups, there is a strong chance of ending up with a number of competitors tied on the same number of points. Appendix C provides systems for breaking ties.

T.4.5 Knock-out competitions

Usually, the semi-finals and the finals of an event is a knockout competition.

In each semi-final pair, the highest scoring skipper from the previous stage gets the benefit of entering on starboard in the first match (being the yellow boat). This gives him a chance of one extra starboard advantage (starboard in 1st, 3rd and 5th matches as opposed to 2nd and 4th matches).

Tradition suggests giving the winner (W) of the round robin (or quarter-finals) the privilege of choosing his opponent (O). The better (B) of the two other boats will meet the last (L) remaining boat

Flight ⇒ Match ↓	1 SF		2 SF		3 SF		4 SF		5 SF	
1	O	W	W	O	O	W	W	O	O	W
2	L	B	B	L	L	B	B	L	L	B

The other common system is to have number 1 sail against number 4 and number 2 sail against number 3 as follows:

Flight ⇒ Match ↓	1 SF		2 SF		3 SF		4 SF		5 SF	
1	4	1	1	4	4	1	1	4	4	1
2	3	2	2	3	3	2	2	3	3	2

The finals should be scheduled in such a way that the last match of the event should be deciding 1st - 2nd place i.e. any concurrent petit final should be run as the first match of the flight. To ensure this, it is common to have the petit final 'first to score at least 2 points' when the final is 'first to score at least 3 points'.

During the semi-finals and the finals the skippers normally exchange boats.

The preferred system for this is for the competitors to exchange boats after each odd-numbered match (ISAF Standard SI's). This procedure is included in the Standard Sailing Instructions.

With six boats a suggested schedule is as follows:

Flight ⇒ Match ↓	1F		2F		3F		4F		5F	
1	6	5	5	6	6	5	Wsf	Wsf	Wsf	Wsf
2	Lsf	Lsf	Lsf	Lsf	Lsf	Lsf				
3	Wsf	Wsf	Wsf	Wsf	Wsf	Wsf				

In the table above, L indicates "loser"; W indicates "winner". After the semi-finals there are two winners and two losers.

The most equitable solution is therefore to make a draw: The winner of the draw chooses side or boat for the first match, the loser of the draw chooses what is left (side or boat). The skippers will then exchange side after every match and boats after every odd number match.

Matches to determine fifth and sixth positions could be sailed either separately, during the semi-final series, or as shown here – with the final series.

T.4.6 Repechage

It is possible to organize a repechage (second chance) stage before knockout stages.

The most used format is: Round Robin, (Quarter Finals,) Semi-Finals and Finals.

There is no hard rule about which format to use at an event. All formats are possible, and the format should be chosen depending on the level of the regatta, the ratio of number of boats available vs. number of skippers, the time available for racing (there could be multiple round robin series, or the event could have multiple knock-out series in its final stages).

At high-level events, it is desirable that the winner is decided in a knockout final. This may sometimes be achieved by changing the format by shortening or removing earlier stages. The sailing instructions need to describe this.

The scores always decide winners of the Qualifying stages, Quarter Finals, Semi-Finals and Finals.

In a round robin series, the highest score wins.

In a knockout series, the winner will be the first skipper to reach a certain number of points (usually 2 or 3 points, or even 5)

The scoring is detailed in Appendix C and includes details about how to resolve ties in a match race. When possible, ties can be resolved by a sail off. This is considered as the fairest way of resolving a tie, however, it is not always possible to have a sail off.

T.4.7 Tie break sail off

When a sail off is required to break a tie the following system will resolve the tie with the minimum number of matches and avoid the possibility of further ties.

Port and Starboard assignments is initially random dependant on the draw. Later assignments redress some of the imbalance in the initial draw.

3 Tied Boats - 1 to go through to the next round (or to determine event winner)

- The 3 tied boats draw lots A, B & C.
- A v B > winner = D – loser goes out
- C v D > winner goes through – loser goes out

3 Tied Boats - 2 to go through to the next round

- The 3 tied boats draw lots A, B & C.
- A v B > loser = D - winner goes through
- D v C > winner goes through – loser goes out.

5 Tied Boats – 1 to go through to next round (or to determine the event winner)

In every case, the 5 tied boats draw lots for A, B, C, D & E.

- A v B > winner = F – loser goes out
- C v D > winner = G – loser goes out
- E v F > winner = H – loser goes out
- H v G > winner goes through – loser goes out

5 Tied Boats – 2 to go through to the next round

- A v B > winner = F – loser goes out
- C v D > winner = G – loser goes out
- E v F > loser = H – winner goes through

- H v G > winner goes through – loser goes out

5 Tied Boats – 3 to go through to the next round

- A v B > loser = F – winner goes through
- C v D > loser = G – winner goes through
- E v F > winner = H – loser goes out
- G v H > winner goes through – loser goes out

5 Tied Boats – 4 to go through to the next round

- A v B > loser = F – winner goes through
- C v D > loser = G – winner goes through
- F v E > loser = H – winner goes through
- H v G > winner goes through – loser goes out

The ISAF Standard Match Racing SI's provide wording to ensure that changes of the format is within the rules of the event.

Any change to the schedule should, be announced before the start of a round.

For instance, in a knockout series of first to win at least 3 points, it is recommended not to change it to 2 points once the round is started and skippers already have points.

Changes should ideally be announced at the daily briefing and on the official notice board, or, when that is not possible, it could be made on the water by oral information to each the skippers. The umpires should communicate such changes in order to ensure that everybody is aware of what is happening. These changes are entirely within the discretion of the Race Committee, but careful consideration should be given to the interests of all the sailors involved and the fairness of the decision.

T.5 The Course

T.5.1 Location

The course should be set up as close as possible to the shore, and in a place where spectators can easily watch the races.

Match racing is often conducted in locations that would be considered unsuitable for fleet racing. A sea wall or pier that represents an obstruction for the competitors could be ideal as a viewing point for spectators.

Conditions need not be the same across the racing area.

Competitors accept these conditions; such difficulties are a part of the game.

T.5.2 Configuration

The first leg is always a beat to windward and the last leg always a downwind leg. This is to maintain the classical tactical possibilities in match racing. A single line that is both the starting line and finishing line is the most common.

The Leeward Mark is set directly upwind of the starting/finishing line, and the windward mark set further to windward.

Starboard roundings are the default for match racing (except with strong cross current – see below), because this presents the most tactical challenges.

The usual number of laps is 2, however, if the racing area is limited, it may be set as a 3 lap course. More than 3 laps are not recommended.

The target time for a match race varies between 14 and 20 minutes. Match racing does not use a time limit for a match; however, there is a policy for abandoning a match that should be encouraged (see 14 below).

Variations:

- Number of laps.
- Offset mark if venue has strong current
- To compensate for a strong cross current and to try to obtain a real downwind leg, an offset mark may be laid at the windward mark
- Windward and Offset marks may be left to starboard or port, depending on the current and the wind speed/direction. This should be detailed in the SI's.
- The leeward mark should never have an offset mark.
- There is a provision for the offset marks in the ISAF Standard Match Racing Sailing Instructions. (<http://www.sailing.org/23244.php>)
- A leeward gate may be used, especially on courses where asymmetrical spinnakers are being used on the boats.



T.5.3 Duration

The duration of a match should usually be between 14 and 20 minutes.

If possible, round durations of 10, 15 or 20 minutes should be avoided, to ensure that pairs are not interfering with each other near the marks, and that one match is not finishing as another is starting

For boats around 8m length, the first leg is generally no longer than 0,3NM (depending on wind strength). The expected duration of the first beat should be 4-7 minutes.

T.6 Meteorology

To prevent damage to the boats and to ensure a fair competition, the sailing instructions should provide flag signals for different sail configurations (included in Standard SI).

These flags should be displayed from the race committee signal vessel.

Courses must be laid with the existing wind, and not with the expected wind... An absolutely square line for each match in a flight is a target, but it is not as critical in match racing as it is in fleet racing.

T.7 Equipment Failure

Equipment failure will happen at times and boats may request time to repair gear failure by displaying a flag defined in the SI (in the standard SI: flag L).

The flag must be displayed before the attention signal of the flight (flag F), even if the boat is in match 3 or 4.

When the skipper has just changed over to a new boat, he has a different time limit for requesting a repair. In the standard SI's, this is 5 minutes.

The same time limit would apply if the Race Committee starts the next racing sequence while a boat is still racing. In such a case, that boat has 5 minutes after finishing to display her 'breakdown' flag.

If the breakdown flag is displayed correctly, the Race Committee may allow time to repair.

However, if the breakdown flag is displayed too late, the boat is not entitled to any redress due to damage to the boat, unless the damage was caused by a boat required to keep clear (Standard SI 11.4).

It is important that even when the flag is displayed late, every reasonable effort should be made by the 'repair boat' to assist the boat with repairs or spare parts before she starts racing. However, this must not delay the starting sequence.

The Race Officer may change the order of matches in the starting sequence where one of the boats needs more time for repair. The PRO usually asks the umpires to inform the boats in their match of any such changes. When the RC receives confirmation from the umpires that all boats are informed, they can start the sequence.

When the order of matches is changed in a flight, each match still keeps its designated numeral pennant. For example if a boat in Match 1 needs time to repair and will start at the end of the flight, Match 2 moves up to the first start, but keeps its Match 2 numeral pennant

When one of the boats in a match has damage that requires a change to its normal sailing configuration (traveller fittings broken, torn spinnaker that cannot be replaced quickly, etc.), it may be better to equalize her opponent's boat by conforming it to the damaged boat. This could mean having both boats sail without spinnakers for the next match or fixing the traveller on the centreline for both boats, etc.

The umpires will normally keep a look out for damage flags and should report damage to the Race Committee during the match, in order that preparations can be made to fix the problems without loss of valuable sailing time.

In such situations, the Race Committee should consult the Chief Umpire before starting the next flight.

T.8 The start

T.8.1 The line

Length: It is suggested that the starting line be approximately 30-40 seconds in length (as a minimum). As an example, if a boat is reaching along the starting line at 5 knots speed, it will travel approximately 2.5 meters per second. In these conditions, the appropriate length of the starting line would be approximately 75-100 meters.

Angle: With a perfect starting line and both boats entering on time, both boats may come together in the middle of the line in a dial up. If the boat entering from the port end is consistently crossing the boat entering from the starboard end (crossing either to windward or to leeward), there is a problem with the starting line. Usually, the problem is a result of one or more of the following:

- The starboard end of the line is too favoured (wind shift to the right).
- The effect of current has not been properly taken into consideration.
- The race committee boat anchor line is extending too far in front of the Race Committee Signal boat and is obstructing the boat entering from the starboard end.
- The line flag is too far aft on the Race Committee Signal boat.

In such cases, the Race Committee should adjust the starting line by a combination of

- Moving the port end starting mark to windward or to leeward, depending on whether it is a windward or leeward cross,
- Placing a sentinel on the anchor line, to change the angle of the anchor line.
- Repositioning the flag defining the starboard end of the starting line toward the bow of the Race Committee Signal boat.

T.8.2 Starting Procedure

The starting procedure for match racing is described in rules C3.1 & C3.2.

- Attention signal, flag F displayed 10 minutes before the first starting signal. (At many events, the SI changes this to 7 minutes.)
- For each pair, a warning signal, which is the numeral pennant corresponding to the match number displayed 5 minutes before the starting signal.



- preparatory signal, flag P, displayed 4 minutes before the starting signal.
- If one or both boats have not completely crossed and cleared the starting line (the first time) from the course side to the pre-start side, the race committee will display the ID flag(s) of the boat(s) with a sound signal, until the umpires have penalized the boat(s) or for one minute – whichever is earlier. See rules C4.1 and C4.2.
- At the starting signal, the numeral pennant and flag P are removed.
- The starting signal for one match is the warning signal for the next match in the same flight.



Starting Signals – Rule C3.1

<i>Time in minutes</i>	<i>Visual signal</i>	<i>Sound signal</i>	<i>Means</i>
<i>10 (or such other time as designated in the Sis)</i>	<i>Flag F displayed</i>	<i>One</i>	<i>Attention signal</i>
<i>6</i>	<i>Flag F removed</i>	<i>None</i>	
<i>5</i>	<i>Numeral pennant displayed*</i>	<i>One</i>	<i>Warning signal</i>
<i>4</i>	<i>Flag P displayed</i>	<i>One</i>	<i>Preparatory signal</i>

2	Blue or yellow flag or both displayed **	One**	End of pre-start entry time
0	Warning and preparatory signals removed	One	Starting signal
<p>* Within a flight, numeral pennant 1 means Match 1, pennant 2 means Match 2, etc., unless the sailing instructions state otherwise.</p> <p>** These signals shall be made only if one or both boats fail to comply with rule C4.2. The flag(s) shall be displayed until the umpires have signalled a penalty or for one minute, whichever is earlier.</p>			

Note

Code flags are sometimes replaced by flags with numbers, in different colours : 10 (or 7), 5, 4 (1), written on them, to help spectators understand the starting count down.

T.8.3 Requirements before the start: Rule C4.1

*C4.1 At her preparatory signal, each boat shall be outside the line that is at a 90° angle to the starting line through the starting mark at her assigned end. In the race schedule pairing list, the boat listed on the left-hand side is assigned the port end and shall display a blue flag at her stern while **racing**. The other boat is assigned the starboard end and shall display a yellow flag at her stern while **racing**.*

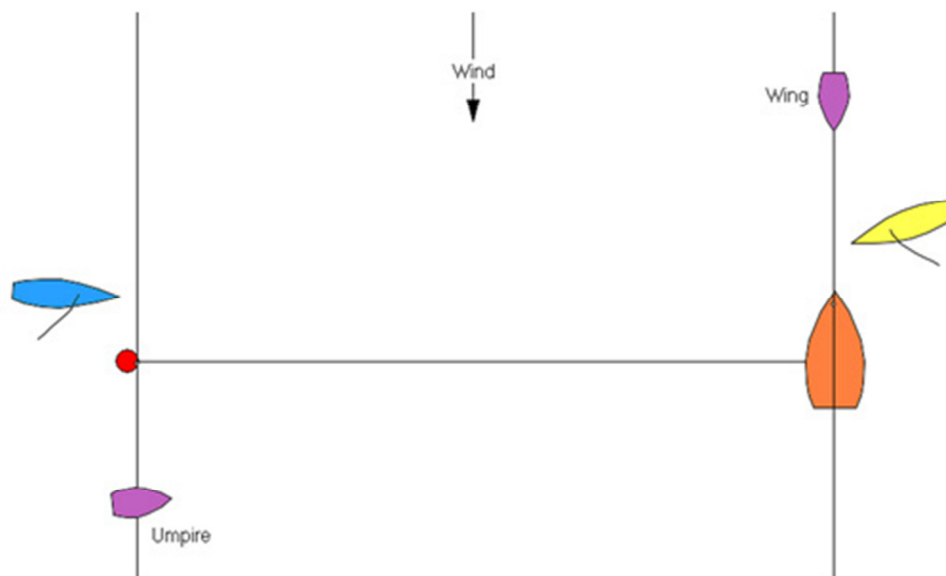

At the preparatory signal, both boats should be outside a line that is at a 90 degrees angle to the starting line (perpendicular).

The wing boat monitors Yellow's entry and if Yellow enters early, they will inform the umpires by radio.

The wing will not signal if Yellow enters correctly.

The umpire boat monitors Blue's entry.

If either boat enters early, the umpires will penalize it.

Sometimes there is no designated wing boat, and the umpires will take turns in winging for each other. That system leaves the last match without a wing boat and the Race Committee may be asked to monitor the Yellow entry for the last match in each flight, and when relevant, radio to the umpires if Yellow enters early.

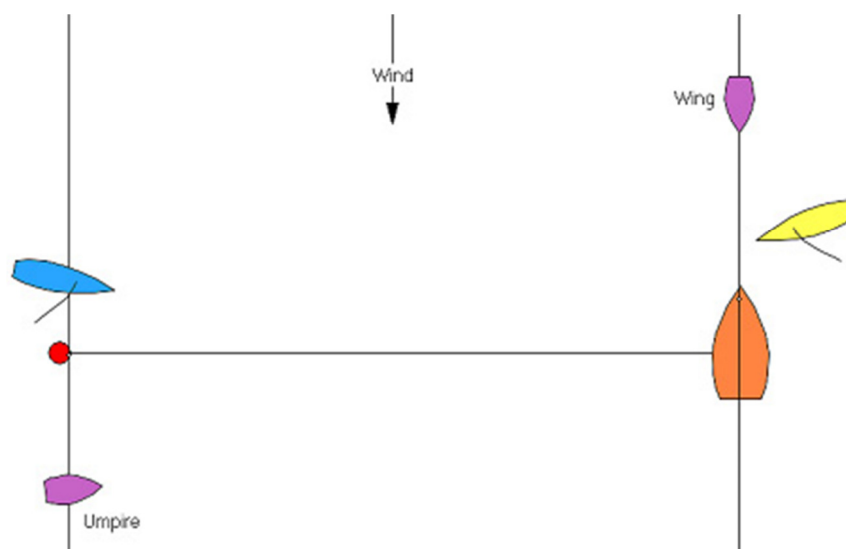

The umpires make the judgement about the boats' positions at the entry and any penalties will be signalled by them and not by the Race Committee. In this diagram, Blue is not entirely outside the perpendicular at the time of the preparatory signal (4 minutes), and the umpires will signal a penalty to Blue.

Note that the perpendicular line is perpendicular to the starting line and not parallel necessarily to the direction of the wind at the time of entry.

T.8.4 Requirements before the start: Rule C4.2

C4.2 Within the two-minute period following her preparatory signal, a boat shall cross and clear the starting line, the first time from the course side to the pre-start side.

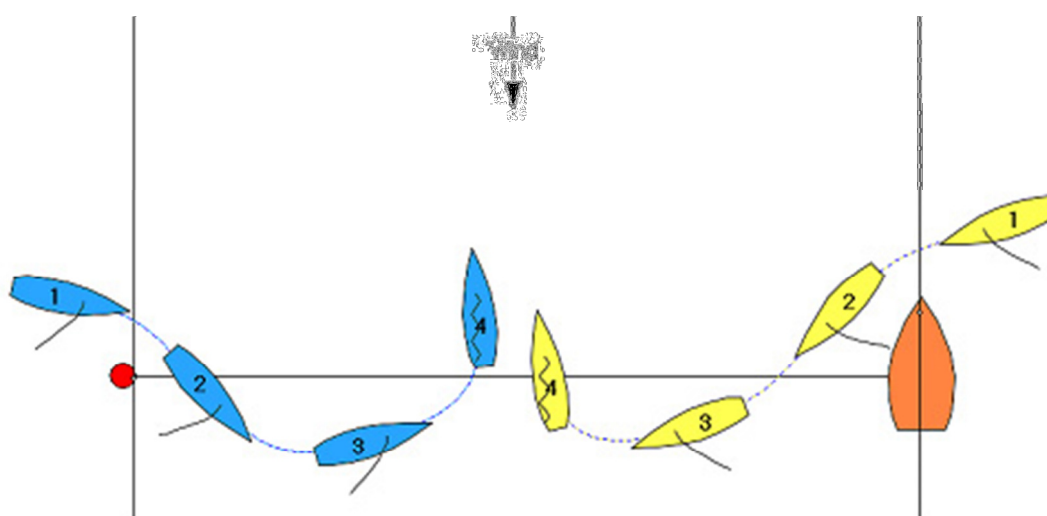

Position 1: preparatory signal, both boats outside their correct end

Position 4: 2 minutes before the starting signal, both boats have entered correctly. No flag, no sound signal

T.8.5 Individual Recalls: Rule C 3.2(a)

C3.2(a)(1): When at a boat's starting signal any part of her hull, crew or equipment is on the course side of the starting line or one of its extensions, the race committee shall promptly display a blue or yellow flag identifying the boat with one sound. The flag shall be displayed until the boat is completely on the pre-start side of the starting line or one of its extensions or until two minutes after her starting signal, whichever is earlier.

At the starting signal, both boats are to windward of an extension of the starting line. The race committee must PROMPTLY display a blue and a yellow flag, with one sound signal.

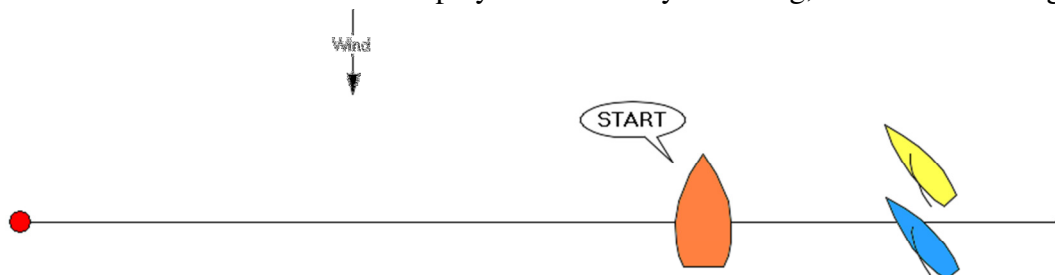

Each flag shall remain displayed until the relevant boat is completely back on the pre-start side of the starting line or its extension, or until two minutes after the starting signal, whichever is earlier.

C3.2(a)(2): When at a boat's starting signal no part of her hull, crew or equipment is on the course side of the starting line or its extensions, and before she starts she sails to the course side across an extension, the race committee shall promptly display a blue or yellow flag identifying the boat. The flag shall be displayed until the boat is completely on the pre-start side of the starting line or its extensions or until two minutes after her starting signal, whichever is earlier.

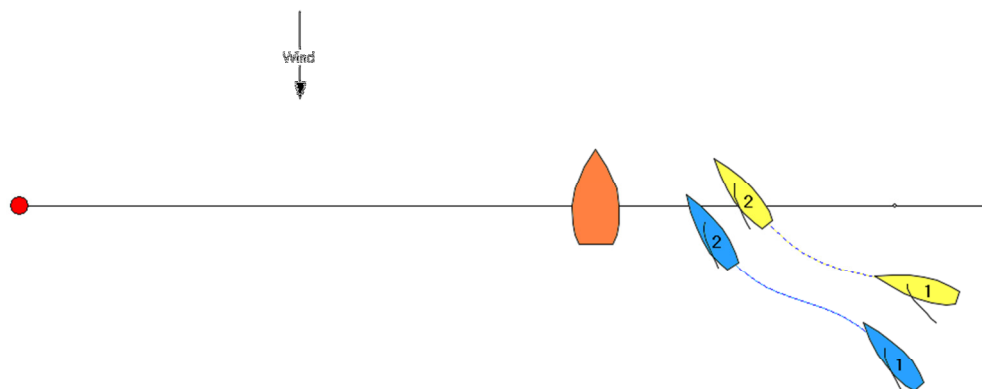

Position 1: starting signal, both boats are to leeward the line.

Position 2: after the starting signal, both boats cross an extension of the starting line. The Race Committee shall promptly display a blue and a yellow flag – with no sound signal. If only one boat had crossed, only one flag should be displayed.

- General recall is never used in match racing.
- The recall flags are the blue and/or yellow flag corresponding to the ID flag of the OCS boat(s). Flag X is not used for recalls.

Any recall signal must be made within 1-2 seconds after the starting signal.

The later a recall signal is given, the more likely it becomes that there will be a request for redress.

When the recall signal is late and a boat displays a red flag, and the Race Committee or the umpires are convinced that a request for redress would be granted, it is best to abandon that race and to restart it immediately. The Race Committee may want to talk to the umpires on the match before making the decision if they have any doubt. Abandoning the match immediately in such circumstances will save a lot of time compared to completing the match and then having to resail it after a protest committee decision.

A recall flag should be lowered exactly at the moment when the recalled boat is completely back on the pre-start side of the starting line or its extensions – or after two minutes if the boat is not returning to the pre-start side of the line, which should not happen if the recall is clearly signalled.

The timing of lowering the recall flag is very important and the signal must be very clear. The sailors are continuously checking the flag to know when they have cleared the starting line in order to start properly.

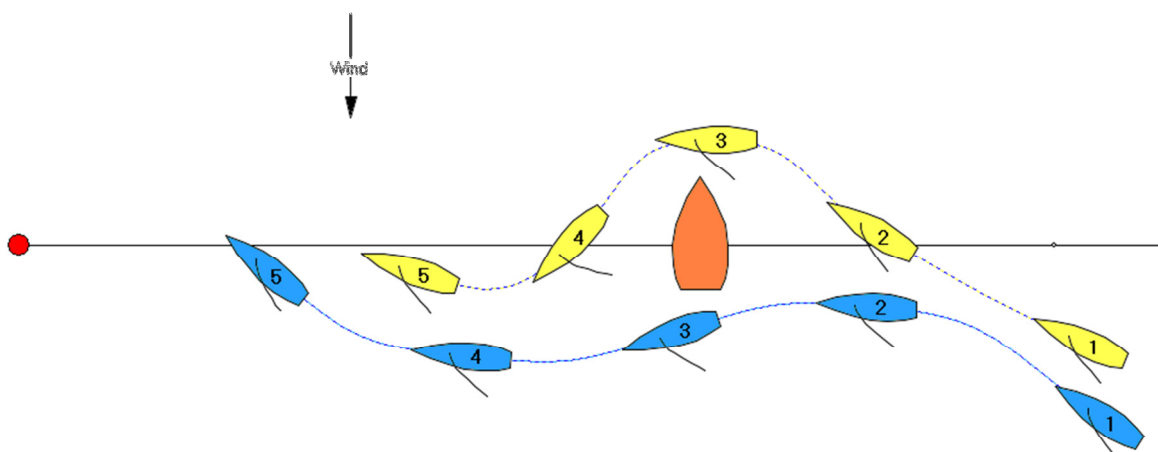

Diagrams are after the starting signal. The race committee must promptly display a yellow flag at position 2 - and remove it shortly after position 4 when Yellow is completely on the pre-start side of the starting line.

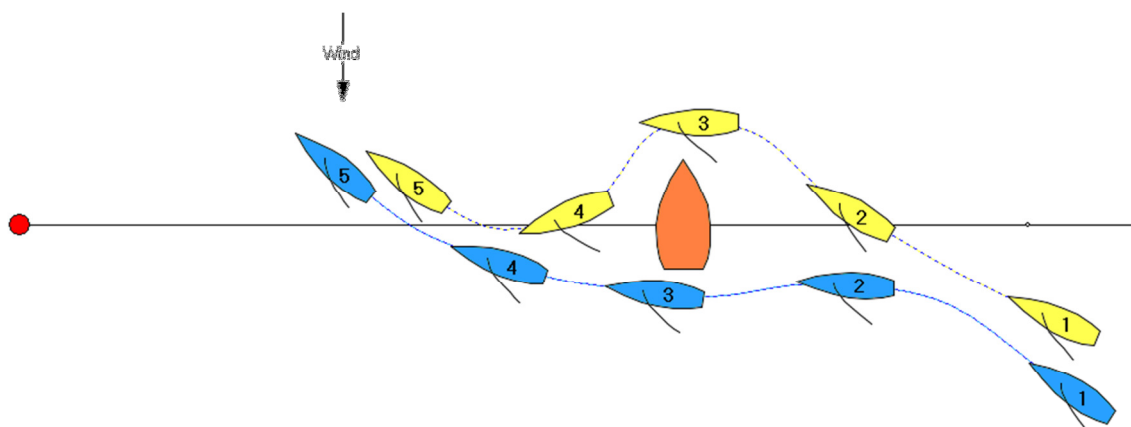

The race committee must display a yellow flag at position 2.

Because Yellow never completely crossed and cleared the starting line, the yellow flag remains displayed until the boat has completely returned to the pre-start side of the starting line or its extension or until 2 minutes after the starting signal, whichever is earlier.

T.9 Postponement

T.9.1 Postponement before the starting sequence:

If the conditions do not permit fair racing, do not hesitate to postpone (see 13 below). The policy about abandonment applies to postponements as well.

T.9.2 Postponement during the starting sequence

Unlike in a fleet race, where an error in the starting procedures should always result in a postponement, this is not the case for match racing. Should a flag be late or a sound signal missing – watch the competitors. If they both behave as if the signal has been given correctly – and neither put up a red flag, simply get the flag up if it is missing or disregard the missing sound signal. Should one or both sailors put up a red flag, the match should immediately be postponed and restarted.

Remember that similar to abandonment, a postponement will cancel any advantage a boat has gained.

T.10 Changing the next leg of the course

When, Where and How to Change the Course

A race committee must always be aware of how the course configuration is affecting the boats. Ideally, the windward and downwind legs will be square. This provides the most opportunities for lead changes. If the boats spend substantially more time on one tack than on the other, especially downwind, the course should probably be adjusted.

In match racing using the ISAF SI's, the only mark that may be changed while racing is the windward mark.

The procedure for changing the next leg of the course must be described in the sailing instructions, and the ISAF Standard Match Racing SI 13 contains the most common options.

The Standard SI provide for a system for changing the first leg from the Race Committee Signal boat together with the preparatory signal for each match. This means that in shifty conditions, it is possible to send Match 1 to the original mark 1, Match 2 to an alternate mark, and then Match 3 to the original mark again... The signal must be followed by a series of repetitive sounds signals and it should be removed at the start. It is common to display this from the bow of the signal boat. If the sailing instructions describe it, flag C should be displayed with a flag or board in the colour of the change mark.

The procedures for changing the next leg of the course after the start are the same as in a fleet race, except that only flag C is used, and not +/-, red/green or compass courses.

Changes after the start are signalled at the Leeward mark, as the starting line is also the finishing line (ISAF recommendation: the finishing line should not be moved).

If the change applies to only one match, flag C must be displayed with the corresponding numeral pennant.

Each match may be given a signal about a change of the next leg of the course and it is therefore common that the sailing instructions provide for the use of a flag or a board indicating the colour of the next mark together with flag C.

As there is usually more than one match on the course at the same time, frequent changes may be needed in shifty conditions, and the Race Committee needs to be aware of the identity of each match as they approach the leeward mark.

Because of this, it is possible to have several different courses being used by different matches in the same flight.

An option that works well when the conditions are known to be shifts is to lay 3 windward marks of clearly different colours in the water. The default mark is usually white or orange. The other two marks are of other distinguishing colours, such as green and red. If there is a change of course, the flag C will be displayed together with the appropriate coloured flag (or a board) to show which the next mark is. The marks may get moved around, depending on wind direction changes, so sometimes the default or original mark may end up on the left or right side of the other marks. If this option is being used, the wording must clearly reflect which mark is the default mark (the 'original' mark).

T.11 Shortening the Course

In match racing, flag S is never used for shortening the course. In addition, courses are not shortened by removing legs after the start in match racing. If the Race Committee wants to make a leg shorter, they simply signal a change of course and set the new windward mark at a lesser distance than the previous windward mark.

The other way of making the course shorter is to signal that a shorter course will be sailed. It is common that the sailing instructions provide for a 1, 2 and 3 lap course. The default would normally be a 2 lap course, so when no signals about the course is being displayed, it is a 2 lap course.

There is no time limit for a match; however, it is common to use a time limit of 5 minutes after the first boat finish.

T.12 Abandonment

When a match needs to be abandoned, it should happen as quickly as possible. The longer a match has lasted, the more the competitors have invested in the match.

When abandonment is being considered because of a lack of wind, it is highly recommended to ask the umpires of the match who will have a detailed knowledge about the situation for that match.

Unlike in fleet race, the umpires (or the chief umpire) may contact the race committee and offer their opinion that something has happened that is likely to result in a request for redress which they believe they will uphold. The umpires will then suggest abandonment. In such cases abandonment is recommended but the final decision lies with the race committee.

Under what circumstances a match should be abandoned?

Guidelines can be found in Call MR 27 and as listed in IU news 1 2006:

CALL MR 27

Rule 32.1(e) *Abandoning after the start*

Rule 62 *Redress*

Rule C9.2 *Requests for Redress – Official boat interfering with competing boat*

Rule C9.3 *Other Proceedings – following action or non-action by umpires*

Question

Under what circumstances should a match in progress be abandoned?

Answer

After the preparatory signal a match should be abandoned only when the umpires and race committee are sure that a claim for redress would be upheld were the adversely affected boat to lose the match or for reasons of safety. It is then preferable to abandon the match immediately. The following are examples:

- a. a late or incorrect recall signal*
- b. serious interference with a competing boat by an umpire or other official boat*

During the preparatory period the match may also be postponed

A match should not be postponed or abandoned due to an incorrect umpire signal. In this case rule C9.3 applies.

In order to provide consistency through an event and also in different events around the world, ISAF has published an abandonment guideline with clear criteria. The goal is to get the same decision in the same conditions and to place all the actors (RC, umpires, sailors) on the same page.

From IU news 2006 issue I:

The decision to abandon a match race should be based on the following criteria:

- a. At the preparatory signal, either boat does not make enough progress to be able to fulfil the entry requirements,*
- b. In the pre-start period, boats are unable to circle and maintain steerage,*
- c. On the first beat, either boat sails into the zone around the windward mark without tacking after starting, or*
- d. Neither boat makes significant progress for two minutes.*

Note that in order to avoid abandonment, a leading boat may tack when it is not necessary, to convince the Race Committee that the first leg is indeed a beat to windward. In the same way, the last criteria should be used with caution when the boats are on the last leg of the course. However, once the decision to abandon has been made, it should happen without delay.

T.13 Relationships with Umpires

In Match racing regattas, the various race officials' work closer together than what is normal in a fleet race

Although there are rules that establish and define the functions and responsibilities of the umpires and the race committee, the PRO and the chief umpire must work closely together. Every day they must prepare and conduct the daily briefings with the competitors together, and discuss any matters arising.

The morning briefing is normally chaired by the PRO, whereas the briefing after sailing is normally chaired by the Chief Umpire or another umpire designated that task. At most events, the umpires are present at the morning briefing as well, and the PRO sometimes attend the briefing after racing.

Race committees may be managing up to 5 matches at the same time, so when an important decision about a particular match has to be made on the water, it is important, whenever possible, to consult with the Chief Umpire or the match umpires, to receive an accurate assessment of the situation for that particular match and also probably direct input as to what should be done with that match.

T.14 Match racing penalty system

The default is that a penalized boat may delay taking her penalty, as long as she takes it before she finishes.

Whenever a boat completes a penalty, the umpires will give a sound signal (whistle) and remove their penalty flag. When a boat with a penalty approaches the finishing line, the umpires will inform the race committee about the penalty, and sometimes also keep an open radio to ensure that the Race Committee hears the signal when the penalty is completed.

Penalties in match racing are:

- On a windward leg; Gybe and as soon as reasonably possible, luff to a close-hauled course.
- On a downwind leg; Tack and as soon as reasonably possible bear away to a course that is more than 90° on the true wind.

Boats may not take a penalty within the zone of a rounding mark. However, they may take it within the zone of the starting or finishing marks, and also, when the leeward mark is not a mark of the course, they may take a penalty around it if they wish (or even touch it).

If one boat has a penalty and the other boat gets a penalty, the penalties will be offset so that neither boat will have a penalty. This does not apply when the penalty is a red-flag penalty. See below.

If a boat has two penalties, it must take one of them as soon as reasonably possible, but not before starting.

If a boat has more than two penalties, the umpires will disqualify her and award the match to the other boat. The disqualification will be signalled by the display of the blue or yellow flag and then a black flag, and a sound signal. When a boat has been black-flagged, the umpires will inform the Race Committee that the match is terminated and that the opponent is awarded the match. This means that the opponent does not have to finish the match.

If a red flag is displayed with or soon after a penalty flag, the penalty shall be taken as soon as reasonably possible but not before starting. A red-flag penalty cannot cancel or be cancelled by another penalty.

The umpires may initiate certain penalties under rule C8.

T.15 Sighting the Finishing line

Race Signal Blue flag must NEVER be used in Match Racing by the Race Committee. It could easily be confused with the blue flag that is used to signal penalties to the blue boat and to signal when the blue boat is OCS.

The definition Finish is changed for match racing in rule C2.1 to allow a boat to take a penalty around the finishing mark and then finish. The amended definition clarifies that when a boat with an outstanding penalty crosses the finishing line, but the penalty is thereafter offset because the other boat receives a penalty, she must be recorded as finished the first time she crossed the finishing line.

The umpires will advise the race committee about any outstanding penalties, and it is important to continue monitoring the boats and any signals from the umpires when this happens. The moment a boat completes a penalty, the race committee must decide whether all parts of the boat's hull and equipment is on the course side of the finishing line before the boat finishes.

The umpires will normally inform the Race Committee of any outstanding penalty on the last leg.

The boats may finish very close together, and there may be close tactical manoeuvres at the finishing line, so the race committee must be ready to have a very precise finishing line sighting (2 race officers when possible) in order to cover all very tight finishes and be able to declare a winner. However if the RC cannot declare a winner and determine that the race finished in a 'dead heat', Appendix C10.1 covers the case by giving each boat a half point. (This is extremely rare.)

The definition Finish includes the term 'in normal position', and the Race Committee must pay attention to the position of the spinnaker as the boats cross the finish line.

Should one of the boats ease the halyard to get the spinnaker further forward, that boat will not finish in accordance with the definition until its bow crosses the finishing line because the spinnaker is not in its normal position.

Match Racing Call UMP 18 also clarifies that a spinnaker, while being hoisted or lowered, is not in its normal position:

CALL UMP 18

Rule C2.1 ***Changes to the Definitions - definition Finish***
Definitions ***Clear Astern and Clear Ahead; Overlap***

Question 1

At a close downwind finish, Yellow eases her spinnaker halyard, sheet and guy so that the sail is further ahead of her bow than normally. When does she finish? What action should the umpires take?

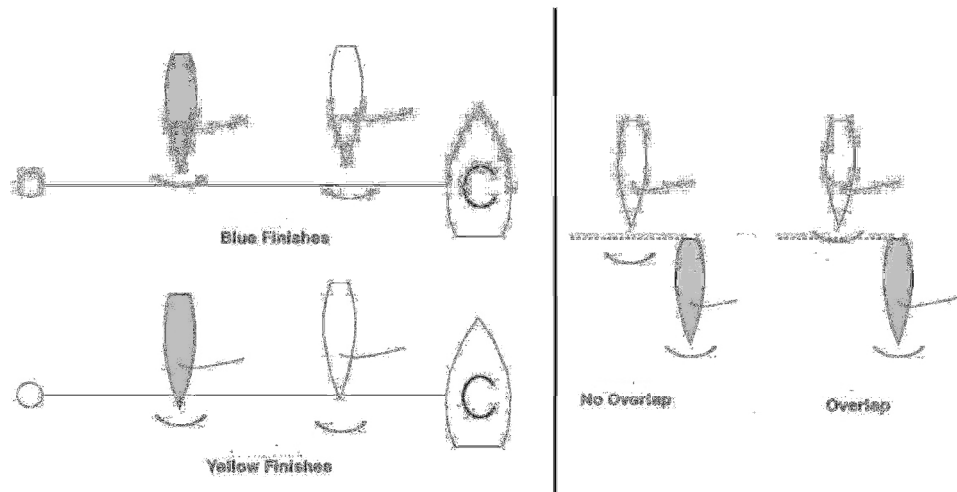

Answer 1

Yellow finishes when her bow crosses the line. The definition Finish makes it clear that as the spinnaker is not in normal position it cannot be considered for the purpose of finishing.

Judging the finish is solely a matter for the race committee. However, if the umpires see the halyard eased they may advise the race committee, since the umpires may be in a better position to see the spinnaker before the boat crosses the finishing line.

The same reasoning would apply when two boats approach a leeward mark and there is a question about whether they are overlapped.

Question 2

Would the answer be different if Yellow was in the process of taking down the spinnaker?

Answer 2

No. A spinnaker in the process of being set or taken down is not 'equipment in normal position' in the context of the definitions where this term is used.

It is common practice for the Race Committee to display the flag of the winner of the match (Blue or Yellow). This is simply a service to the competitors and carries no weight under the rules.

When one match is finishing while another match is starting, it is important not to signal the finish with the flag of the winner, as this may be misinterpreted for a recall signal for the match that is just starting and could lead to confusion and requests for redress in the other match.

T.16 Scoring

The Race Committee shall note the results of all matches and use them to establish the scoring (Rule C11). A win gives one point and a loss no points.... a dead heat is half a point for each.

Ties in the number of points are common in match racing and depending on the event format and the number of ties, they may be quite complex.

Rule C11 gives guidelines on how to resolve ties, and there may be additional tie breaking rules in the sailing instructions.

At most events, the chief umpire will designate another umpire to keep track of scores and to assist the Race Committee with scoring issues and the resolution of ties. This is just a back up system. The primary obligation for scoring is with the Race Committee. This is just another example of the Race Committee and umpires working closely together in match racing.

When a tie cannot be resolved, the best solution is to have a sail-off. The system for organizing sail-offs are described in 4.7 of this manual.

T.17 Race Committee organization

T.17.1 Race Committee boat

There should not be too many people on the RC boat, between 5 and 7 (some race committees will find they operate efficiently with even fewer).

- 2 persons at flags
- 1 timekeeper + sound signals
- 1 line sighter (sights the line at the start to call if any boats are over)
- 1 race officer, checking the boats at the start, and the finish, and communications with the mark layer
- 1 or 2 persons to record results and make notes (may also be done by one of the two assigned to flags...)

Sound signals: The best practice is a gun for flag F, and a horn for all subsequent signals. However, a horn for the F flag is acceptable. Whistles should not be used so as to avoid confusion with the umpire's signals.

The starting procedures are long and detailed. The timekeeper must be very focused and conscientious (a big watch that can be seen by everybody is quite valuable to avoid mistakes). Use of the timetable at the end of this section (paragraph 19) may help avoiding timing errors.

It is easy to get distracted by the ongoing pre-start manoeuvres and this may lead to timing errors, mistakes in the display of the appropriate flags or wrong sound signals.

For recalls, Blue and Yellow flags must be set on poles and not on a halyard to ensure immediate display and increased visibility. These flags for OCS are best displayed from the forward part of the Race Committee signal boat, separate and apart from the other signal flags. This allows the competitors to clearly see the OCS flags without confusing them with other signal flags on the aft part of the boat. This also helps to prevent redress requests.

Below is an example for the other flags.

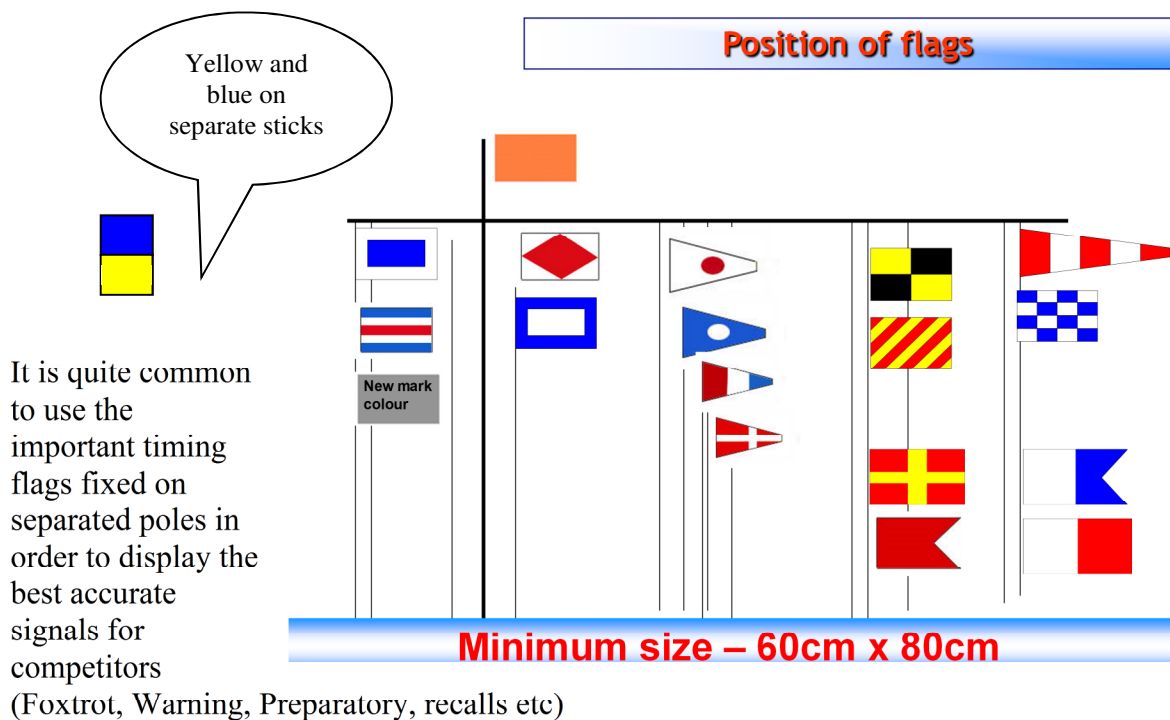

The best practice is to use 1 pole per flag instead of halyards.

Note: another system using flags with numbers is also used, with the idea of being understandable for the media



T.17.2 Line sighting

As mentioned previously; line sighting is essential and crucial in match racing. When possible, the line should be sighted by two persons. It is then possible for each Race Officer to hold one ID flag and to monitor the position of “his/her” allocated boat in relation with the starting line.

Both race officers need to be positioned so that they can see the line precisely, one above the other.

During the last seconds before the starting signal, each Race Officer loudly describes what his boat is doing relative to the starting line.

If one or both boats are OCS, the Race Officers will immediately display the appropriate ID flags. The sound signal needs to be made immediately after the starting signal. This procedure for announcing each boats’ position helps this to happen promptly.

T.17.3 Race Committee boat

Anchor lines must be as short as possible (without being too short), so as not to interfere too much with Yellow’s entry, or it must be marked by a buoy, which would then be deemed part of the race committee vessels ground tackle (See Standard SI 10.2(c)). A sentinel weight on the anchor line helps to keep the line more vertical and helps to prevent interference with Yellow’s entry.

The orange flag displayed on a mast is the most common way of marking the starting line, preferably located in the middle to front of the Race Committee signal boat. Cross current could influence the idea position for the starting line from the race committee signal vessel,

and in such conditions the competitors should be made aware that the race committee may move the orange flag depending on the current. It is good practice for the umpires to inform the competitors when this happens.

The main wind reference for the Race Officer will be a hand held wind indicator, or the orange flag used as the starting mark.

The race officer should be in constant communication with the mark layers.

T.17.4 Communications

Radio channels

- 2 channels are needed at most events (VHF or UHF)
- A race committee channel
- An umpires channel
- 3 or 4 different channels are ideal (VHF or UHF)
- A public channel: all the Race Committee, the Organisation, the Media, ...
- A working channel, between the Mark Layer and the Race Officer
- An umpire channel
- A private channel, between the Race Officer, the Technical Commission, the PRO and the Chief Umpire

More important than the number of channels available is that everybody agrees about the use of the channels and respects the needs of each other group. This should be discussed and agreed before the event starts.

T.17.5 The Windward Mark Layer

A member of the race committee

- Responsible for laying the course marks (this could include the leeward mark).
- There should be 2 persons on board any mark boat.
- A good mark layer works on his own, and follows the wind with his boat, ready to lay the marks. He also informs the race officer about wind shifts on his own initiative.
- A good mark layer has buoys ready to be laid.
- One solution is to have a cover for the marks that may be placed over the existing mark to display the new colour.
- Another solution is to have 3 windward marks, all of different colours, already set in the water and separated by some distance so that they may be used at a moments notice and without having to lay the new mark at the last moment. The ideal initial distance between these marks will depend on local conditions.
- Windward legs are short (4 to 7 minutes) and course changes may frequently be needed.
- A good mark layer will react rapidly to any request from the race officer.
- If a change of the next leg is signalled with the preparatory signal, the new mark should ideally be in place before the boats start
- It is strongly recommended that the starting/finishing mark be of a shape and/or colour that is distinguishable from the leeward mark.

- An M flag must always be aboard the mark laying boat ready for use in case a mark goes adrift or deflates or worse yet, sinks.

T.17.6 The Leeward Mark Layer

A member of the race committee. May also be managed by the repair boat – but this is not ideal as repair often happens between races and that is when those marks are being moved too.

- In charge of the starting mark and possibly the leeward mark, and any relocation of any of them (the leeward mark is usually only moved between races).
- Signals changes of the next leg of the course in the vicinity of the leeward mark.
- The leeward mark layer boat should have flag C, appropriate numeral pennants and colored flags or boards matching the colors of all the windward marks... and flag M, plus a number of air horns for signalling changes to the windward mark.

T.17.7 The Boat Master – Technical Team

Often called the 'repair boat' or Bosun.

- A local member of the organization.
- Often the person that is managing the boats' maintenance all year long.
- He should have adequate equipment on board to make repairs.
- More than anything else he must be efficient, handy and inventive, all of which helps to save time in making repairs.
- A driver, allowing him to climb on board boats that need to be repaired, should accompany him.
- His radio call signal must be distributed to the umpires, who may contact him directly about collisions and damage. It is important that all groups agree to and are familiar with the procedures for reporting damage. This may vary from event to event.

The most frequent and frustrating cause for delay between flights is the time lost due to breakdowns. No matter how much effort is expended in inspecting and repairing the boats ashore, breakdowns are inevitable. Event organizers are well advised to assign at least one boat, with sufficient, skilled personnel, the exclusive task of repairing boats on the water. The repair boats should be fast and easily manoeuvrable and, if possible, soft-sided since they are often brought alongside the racing boats and have to stay there for some period of time while repairs are being made.

Spares of any items likely to break (such as spinnaker poles, sails, tillers and tiller extensions, sheets, winches, winch parts, winch handles, Y flags and shackles) should be onboard the repair boat as well as tools and sail repair tape. Winch handles and Y flags are occasionally lost overboard by the competitors and need to be replaced. The competitors are charged for those losses.

T.17.8 The Crew Change Team

At most match race events, there will be more sailors than sailboats available, and crew changes may need to happen frequently.

Sometimes the best solution is to have a designated boat to help out with the crew changes between the flights.

At many events, the umpire team may help out with the crew changes, and if the conditions are calm, the competitors may make the crew changes themselves in a knock-out series. However, in a round robin series the changes need to be assisted by inflatable boats unless there is a nearby dock that the boats can sail to without losing too much time.

Match racing pairing lists are made taking the efficiency of crew changes into account. Crew changes should be marked clearly in order for a crew change team to be able to pick up the correct crew and have them ready on the water as the boat they change into crosses the finishing line.

T.17.9 Consistency

A match race event normally consists of a large number of flights, the action is intense, and it is important to keep focus.

It is important that the Race Committee use the same procedures consistently throughout the event.

For instance, most competitors will set their watches to a count down from flag F, whether they start in match 1, 2, 3 or 4. Most watches used have a sync button, and the sailors will be ready to sync at the next signal.

A good match race event has as little waiting time between matches as possible; it simply rolls into the next flight without any unnecessary delays. It is often possible to start the procedures for the next flight before all matches have finished the previous flight, provided the sailing instructions include the standard wording about breakdowns and time for repairs (SI 11). This is also depending on a good schedule for boat changes.

Competitors want consistency from one event to another and from one flight to another.

T.18 Example of timetable

To be adjusted to fit the number of matches per flight. If a 7 minute attention signal is used, this should also be corrected.

Count				
Up	Down	Time	Visual Signals	Sound Signals
0	25	10'	Display Flag F	1
4	21	6'	Remove Flag F	none
5	20	5' Warning Match 1	Display Num pen 1	1
6	19		Display Flag P	1
8	17	2'	Blue or Yellow if needed (rule C4.2)	1 if needed
10	15	0 Start Match 1	Display Flag P and num pen 1	1
		5' Warning Match 2	Display Num Pen 2	
11	14	4'	Display Flag P	1
13	12	2'	Blue or Yellow if needed (rule C4.2)	1 if needed
15	10	0 Start Match 2	Remove Flag P and num pen 2	1
		5' Warning Match 3	Display Num Pen 3	
16	9	4' Prep	Display Flag P	1
18	7	2'	Blue or Yellow if needed (rule C4.2)	1 if needed
20	5	0 Start Match 3	Remove Flag P and num pen 3	1
		5' Warning Match 4	Display Num Pen 4	
21	4	4' Prep	Display Flag P	1
23	2	2'	Blue or Yellow if needed (rule C4.2)	1 if needed
25	0	0 Start Match 4	Remove Flag P and num pen 4	1



ISAF RACE MANAGEMENT MANUAL

SECTION U

Race Management of Team Racing

Contents	Page
U RACE MANAGEMENT OF TEAM RACING	
U 1 Introduction	U 2
U 1.1 Document Overview	U 2
U 1.2 An Overview of Team Racing	U 2
U 1.3 Top things to get right for a successful regatta	U 2
U 1.4 Terms	U 3
U 2 Authority and Responsibility	U 3
U 3 Committees and Key Personnel	U 3
U 3.1 Race Office	U 3
U 3.2 Race Committee	U 4
U 3.3 Protests	U 5
U 3.4 Umpires and Judges	U 5
U 4 Facilities	U 6
U 4.1 Boats	U 6
U 4.2 Further Shore Facilities	U 7
U 4.3 Repair facilities	U 8
U 5 Vessels and Equipment	U 8
U 5.1 Course setting boat	U 8
U 5.2 Umpires	U 8
U 5.3 Marks	U 9
U 6 Race Documents	U 9
U 7 Competition Formats and Selection of Race Area	U 9
U 7.1 Formats	U 9
U 7.2 Selection of Race Area	U 10
U 8 Start of the Regatta	U 11
U 8.1 Competitor registration including damage deposit	U 11
U 8.2 Umpire meetings	U 11
U 9 Setting the Course	U 11
U 9.1 Course geometry	U 11
U 9.2 Location of Race Area	U 12
U 9.3 Length of starting line	U 12
U 9.4 Course	U 13
U 9.5 Adjusting a course for wind changes	U 13
U 10 Starting Procedures	U 13
U 10.1 Starting problems and solutions	U 14
U 11 During the Race	U 15
U 11.1 Fleet surveillance	U 15
U 11.2 Course changes	U 15
U 12 Finishing	U 16
U 13 Things to do at the End of Each Racing Day	U 16
U 14 Things to do at the End of the Regatta	U 16
U 15 Post Regatta Tasks	U 16
U 16 Annex 2.6	U 16
U 17 Annex 6.1	U 17
U 18 Annex 6.1.1	U 21

U.1 Introduction

U.1.1 Document Overview

A successful Team Racing event requires many of the same race management procedures as a fleet race.

This Team Racing Race Management Manual therefore relies largely on the ISAF Race Management Manual. It is intended to be read in conjunction with that document, uses the same overall structure, and only includes content where there are specific distinct requirements for successful Team Racing.

U.1.2 An Overview of Team Racing

Team racing is largely based on fleet racing, with some limited adaptation to maximise two teams racing in close quarters. Team racing uses the same Rules as for fleet racing, with some minor rule changes which are listed in Appendix D of the Racing Rules of Sailing (RRS).

A team racing competition normally consists of many short races (5 to 10 minutes in duration), each between different teams; many team racing competitions will plan on 100 or more races in a day. This drives many of the differences in race management.

There are a number of bases for team racing. Most commonly:

- Teams can consist of 2, 3 or 4 boats;
- Boats can be single or multi handed dinghies, or keel boats.

U.1.3 Top things to get right for a successful regatta

Whilst there are many things to organise for an event, the key ones which underpin a successful event are:

1. An effective management team, with clear roles and good partnership working between the Regatta Chair or lead Organising Authority representative, the Principle Race Officer, the Chief Umpire and the Race Scheduler / Results Coordinator.
2. Crisp organisation, enabling racing to start on time and run continuously with minimal unforced down time.
3. The ability to adjust the course, and move the lines, without any delay to the racing.
4. A well planned basis of competition, with pre-planned contingencies in the event of loss of racing due to weather.
5. Minimal loss of time in teams changing between boats.
6. Reliable equipment, sufficient to withstand the extensive use it will get throughout the event.
7. Effective team spirit / partnership working between Race Committee, Umpires and competitors, fostered by joint social events.
8. Catering arrangements that fit around a full on the water programme, accessible during the day in wet sailing gear.

9. Effective communication to competitors and spectators so all are clear what is happening. Regular briefing meetings from the PRO and Chief Umpire to competitors are essential, but it's important to keep them short.

U.1.4 Terms

Flight: this term has two meanings:

1. A group of boats required for a single race. For instance, for 3 boat team racing, 1 flight consists of 6 boats, 2 teams of 3 boats.
2. A group of races, normally consisting of one race for all available boats.

Format: the format for an event sets out the intended race programme, ie the combination of Round Robin racing and knock out racing that will be run.

Rotations or Schedules: the detailed race order that sets out the teams that are sailing in each race and the boats they are sailing in.

Round Robin: in a round-robin series competitors are assigned to one or more groups and scheduled to sail against all other competitors in their group one or more times.

U.2 Authority and Responsibility

The same organisation authorities apply for Team Racing as for Fleet Racing. However, a team racing event is typically a more dynamic event than a fleet racing event, given the large number of races. It therefore is particularly important to have a good partnership between the key event decision makers:

- The Event Chair or lead representative of the Organising Authority, whose role is to ensure the underlying objectives of the event are met;
- The Principle Race Officer, responsible for overseeing the effective progress of the sailing event;
- The Chief Umpire, responsible for ensuring fairness of racing;
- The Race Scheduler / Results Co-ordinator.

Given the large number of activities that need to be undertaken successfully for a successful event, it is essential that responsibilities are clearly allocated to an individual.

U.3 Committees and Key Personnel

Whilst most structures are the same as for fleet racing, there are some roles with particular demands for a Team Racing event. These are set out below.

In smaller events, it may not be possible to have a dedicated team, in which case typically individuals will take several different responsibilities, depending on ability.

U.3.1 Race Office

The race office is responsible for all the race program schedules (sometimes called rotations) and results. This is generally a very active function during a team racing event due to the large number of races run during a competition.

Entries and registration

At events where boats are provided by the Organising Authority, a damage deposit will normally be taken from each of the teams (see Section 7.1 for more information).

Results and information

At team racing events it is usual to appoint a Race Scheduler / Results Coordinator as a key member of the race management team. This coordinator is responsible for developing the format and producing schedules throughout the competition, and also has a key role in advising on any format adjustments required during the competition (see Section 6.1 for more information).

The logistics of results needs particular consideration at team racing events. Not only are there a large number of races, but it is usually necessary to process the results from one set of races before moving onto the next set, so to avoid delay this needs to happen as racing progresses. Ideally race results will be radioed to the Race Office at the conclusion of each race, so that the overall results can be updated rapidly, which allows race sheets to be brought ashore for formal records when convenient.

Results should be displayed to competitors as soon as possible, so they have an up to date view of progress through the event. Teams should be encouraged to check the results and raise any scoring queries with the Race Office as early as possible.

Open format protest forms and request for redress forms should be available from the Race Office, and logged using standard race management procedures (see Section 2.6.2 and Annex 2.6 for more information on requests for redress).

U.3.2 Race Committee

Course setter

Course setting requires a slightly different approach in team racing to fleet racing. Courses are very short, with often more than one race in progress at any one time. As the aim is for continuous racing the course manager needs to be making minor mark adjustments on an on-going basis as necessary to keep the course optimal without delaying racing.

The course setter therefore needs to be very familiar with team racing course requirements, able to stay constantly on the water throughout racing and be actively mobile with his own motor boat.

Beach master

This role is essential to the efficient running of a team racing event. Most events require a large number of rotations of teams in and out of boats, and the beach master is responsible for ensuring that team changes happen in a timely fashion, and the correct teams swap in and out.

The beach master may also take on a role of ensuring that commonly required replacement kit is immediately available, eg shackles, tiller extensions, both at the change over dock and on umpire boats on the water.

Whilst normally the beach master will be based on shore, if changeovers are all happening on the water it may be preferable to base the beach master on the water.

U.3.3 Protests

Team racing is a test of boat handling skills in close quarters. At top levels it involves teams sailing in very close proximity and pushing rule boundaries to gain advantage. This used to generate a large number of protests, and as a result, on the water umpiring evolved to ensure that, as far as possible, the result on the water is the final race result.

The use of on the water umpiring therefore results in a minimal number of protests. A subset of the umpire team will also form the protest committee if one is required.

On the basis that an appropriately qualified umpire team is in place, top level events will normally apply for the right to deny appeals, so that the result at the event is final. This should be included in the Sailing Instructions.

U.3.4 Umpires and Judges

Umpires are a significant element to any Team Racing event, as umpiring is an integral part of racing.

Depending on the number of umpires available, an event may be observed or fully umpired.

- Observed races (Races with Limited Umpiring, section D2.3 (b) in the Racing Rules of Sailing) have relatively few umpires, who use best endeavours to cover incidents across the entire race. Competitors still retain the right to protest on the water incidents.
- Races with Full Umpiring may typically have 2 or 3 umpire boats, each with 1 or 2 umpires in them. At top events, for key matches, umpire boats will each have 2 umpires, and there should be the same number of umpire boats as boats in a team (ie 2 umpire boats for 2 boat team racing, 3 umpire boats for 3 boat team racing etc).

Number of umpires

Umpires are only needed to cover active races, so the number of umpires required is based on the number of races happening at any one time. For most competitions, it is appropriate to have two umpire boats per active race.

Typically, for racing on a single course, with 3 flights of boats you would expect 2 races at any one time and with 4 flights a maximum of 3 races at once.

Therefore at an event with 3 flights of racing boats, 4 umpire boats with 8 umpires would be appropriate, whereas if there are 4 flights of racing boats then 6 umpire boats with 12 umpires would be ideal. The impact of having fewer umpire boats than ideal is that either some races will be umpired by just one umpire boat, or alternatively fewer races will be held as some race starts will have to be delayed until umpires are available.

Boat set up, gear failure and repair

Measurement is typically not required in a team racing event, as it does not matter whether boats conform precisely to class rules. What is essential is that boats are set up on a standard basis, so that they are as equal as possible and the competition is fair. This is frequently part of the bosun's responsibilities.

When competitors are not permitted to alter settings, it is important to have appropriate settings checked as boats are launched at the start of each day's racing.

Where boats are provided by the Organising Authority, a bosun with supporting boat repair crew is essential to undertake fast maintenance of any breakages.

Damage Officer

The bosun may also be the Damage Officer, and if not, a Damage Officer should be appointed. The Damage Officer is responsible for assessing the cost of any damage and apportioning it to the team responsible. If there is any doubt, umpires may be called on to offer an opinion based on what they saw on the water, and it is possible to go to a formal hearing if necessary.

Redress claims for breakdowns

It is not uncommon to receive claims for redress from teams, particularly at events where boats have been provided by the Organising Authority and suffer breakage. Appendix D5 refers.

It is suggested that the grounds for consider redress requests should be published in advance and strictly adhered to, in order to discourage spurious requests. An example for dinghy racing is included in Annex 2.6.

U.4 Facilities

U.4.1 Boats

Competitor team racing boats

The Organising Authority will be responsible for providing boats for most team racing events. The boats to be provided will depend on a number of factors, in particular what fleets can be made available by the host club, or if sponsorship is available.

The number of boats required will depend on the number of teams at the event. The ideal ratio enables teams to be on the water around 50% of the time, so for example if there are four teams, then one set of boats would be ideal (to enable two teams to race at any one stage). So an 8 team event would have 2 sets of boats, enabling 2 races / 4 teams to be on the water at any one time, etc.

It is still satisfactory if teams are racing between one third and half the time, so eg 2 sets of boats could be used for a competition involving between 8 and 12 teams.

Boat damage is a particular risk in team racing, either from contact with other boats due to the close racing, or from pontoons when teams change boats. Good practice is to put fenders on supplied boats, particularly on bows. Ideally one or more spare boats should be available in case of breakdown to minimise any down time in racing.

The Notice of Race should state what equipment competitors are able (or must) provide. Typically this would include some or all of bailers, protest flags, corrector weights, etc.

Boat identification

Clear boat identification is needed for several different groups:

- Competitors need to be clear which boats to get into, and to be able easily to distinguish their team when racing;
- Umpires following behind boats need to be clear which boat and team;

- Start and finish boats need to be able to see which boat and team;
- It should be obvious to spectators which team is which.

A combination of identifiers may be needed eg:

- Boat numbers on either side of the bow and repeated on the transom;
- The same number on the mainsail;
- Flights with colour coded sails, especially the jibs;
- If more than one flight has the same numbers then coloured tape / ribbon attached to the shrouds works well to distinguish them.

Competitor change over

Enabling teams to change rapidly between races is a key element to fast progression through races. Another factor to consider is the need to minimise the risk of damage. Precise arrangements will depend on the logistics of the venue, the boats used for team racing, wind conditions etc, options include:

- A convenient pontoon, well protected to minimise boat damage;
- A floating dock, moored near the race areas;
- Ferrying teams to and from the race area, using a rib, and using the rib for the changeover. This is often the most effective providing sufficient ribs are available.

In order to minimise the risk of delay or boat damage at change over, it is best practice where possible to change only one team at the finish of a race, ie once afloat and in their boats, teams do two races before changing.

U.4.2 Further Shore Facilities

Fuel

Team racing tends to generate significant use of support boats, for ferrying competitors for change over, mark moving, and particularly for umpires who are in constant motion following races. Contingency arrangements for additional fuel during racing should be considered in addition to ensuring all boats are full of fuel at the start of racing.

Use of club house

The pattern of team racing during an event is generally quite different to fleet racing. In most events, teams will be on and off the water throughout the day, with at least half the time spent on shore waiting in sailing gear.

Adequate provision is therefore needed for access to shelter and food in wet sailing gear throughout the racing day.

Food

In general, team racing will operate continuously during a day, with no formal rest breaks. Food needs to be provided on the go for all officials and competitors.

Team racing is very demanding on the race management team and umpires. Whilst at some events those on the water will be able to step ashore for a break, in many events they will be involved in continuous racing all day throughout the competition.

It is therefore important to ensure they have adequate food and drink available; for instance, tea and coffee available on arrival and at morning, afternoon and lunch breaks; also, if racing needs to happen late, sending out some food later in the day as well as at lunch time will be appreciated.

Competitors will want food readily available throughout the day, accessible in any short breaks they have between races.

U.4.3 Repair facilities

Team racing results in boats being involved in close, hard racing over several days. It is therefore not unusual particularly in strong winds to see gear failure. Even where a spare boat is available, it is important to have staff and facilities on hand to enable rapid repair of any damage. The most common failures are toe straps and tiller extensions. It is therefore useful to have all tiller extensions with quick release attachments and a supply on the water in umpire and course boats.

Time spent in advance to set boats up as robustly as possible to prevent damage during the event can be a good investment. For example:

- Check all halyards have knot stoppers;
- Check all shackled fittings are tight - use pliers.
- Tape all shroud pins and any sharp items;
- Check toe strap mountings and that toe straps are tied securely with good quality (4 or 5mm) line;
- Check all fittings in the boat for attachment and serviceability.

Having a check list for each boat makes things easier and ensures a standard approach for each boat.

U.5 Vessels and Equipment

U.5.1 Course setting boat

The course setting boat required for team racing is different to that for fleet racing. Distances are relatively short, course changes are constant small adjustments while racing continues, so the boat must be reasonably fast, easily manoeuvrable with limited wash, and be suitable for frequent lifting or dragging of marks.

U.5.2 Umpires

There are a number of requirements for the ideal umpire boats:

- Umpires need to get very close to racing boats to see what is happening, so the umpire boats need to be easy to manoeuvre going forwards and in reverse, and create as little wake as possible;
- Umpires will be in the boats all day, so they should be reasonably comfortable eg steering wheel;
- There need to be adequate numbers of umpire boats, as there will be at most 2 umpires per boat.

U.5.3 Marks

Marks only need to be visible over a relatively short distance so small pole marks with flags are perfectly satisfactory. Marks should also be easy to move, ideally able to be dragged rather than requiring lifting, so that the course can be adjusted constantly during racing to minimise down time. Note that team racing sailing instructions frequently permit contact with flags providing there is no contact with the mark or pole.

An alternative eg where depth of anchoring is problematic, is to lay several marks and be able to direct teams to the appropriate mark. This could be through having the ability to put flags on top of a post on the mark, so the course manager can just move flags to change marks. Another approach is to lay several different colour marks and for the race committee boat to indicate which is correct for that race.

U.6 Race Documents

There are some important elements to include in the Notice of Race and Sailing Instructions (SIs) for team racing. Example SIs for team racing can be found at: www.teamracing.org.

As well as the event structure, the Notice of Race needs to set out whether boats will be provided by the Organising Authority or the competitors; as well as anything else competitors need to know in advance eg do they need to bring protest flags, bailers, damage deposit requirements etc.

The Sailing Instructions should include changes to provide the Race Committee with more flexibility than in normal fleet racing. For instance, it is usual to:

- Reserve the right to amend the intended format of competition in order to optimise racing;
- Provide the option of moving marks at any time other than when a fleet is actively rounding them;
- Not to require boats to be off their moorings at the preparatory signal.

U.7 Competition Formats and Selection of Race Area

U.7.1 Formats

This section provides a high level introduction to the typical formats of a team racing event, and sets out some differences to fleet racing objectives. More detail on format options is provided in Annex 6.1.

At its simplest, team racing consists of two teams, each consisting of several boats, which compete in a race against each other. Special rules (see *RRS D*) apply. The winning team is the one with lower total points, where the points for each team are the total sum of the results of each team member boat. If the teams are tied on points, the team without first place wins.

The most rapid team racing competition is a straight knock out, where the losing team stops sailing, and the winning team continues in the competition to sail other winning teams. The knock out format is normally only used in the final stages of a competition. If used from the start it would result in very limited racing for losing teams.

Instead team racing events tend to start with one or more Round Robins. In general:

- The first rounds are either all teams sailing all other teams, or with teams divided into groups of broadly comparable standard.
- Later rounds filter teams based on previous results to create performance based groups, thus providing sailing against teams of similar standard.

The format for an event sets out the combination of Round Robin and knock out racing that will be run.

There is always a tension between running a very extensive race programme that maximises the sailing for competitors and ensuring that the final races complete so that a good result is obtained from the event. The race team should plan in advance a programme based on the maximum racing that could take place, with a series of contingency plans that allow the programme to be adjusted should racing not be possible for some of the time.

The annex sets out some more detailed considerations to help in constructing or reviewing a format.

Schedules

In most team racing events, there are a large number of races with teams changing in and out of different sets of boats. It is therefore important for the effective running of a competition that clear schedules are made available to teams and officials in advance of racing. It can be helpful to provide a supply of plastic wallets or laminated copies. An example schedule is shown in Annex 6.1.1.

For most efficient sailing, the schedule will be customised to the precise conditions, allowing for the numbers of teams, the format of racing, the fairness of boats, the ease of change over etc.

Rescheduling re-sailed or postponed races

It is not uncommon in team racing to have boat breakdowns that cause delay. If the delay is significant, normal practice is to postpone that race and carry on with the schedule. There may also be a need to re-sail races, following claims for redress (eg major equipment failure through no fault of the crew – see section 2.6).

It is usually best to re-schedule races to the end of the round, or as either the last races of the day or the first races of the next day. It should be clear who is responsible for deciding on such schedule changes – normally the Race Office managing results and future schedules is best placed to advise the Race Officer. Clear communication to competitors and officials is then necessary to avoid confusion.

U.7.2 Selection of Race Area

The selection of a race area needs to consider a number of factors.

- Team racing can be a good spectator sport. The ideal location for a course is close to a place or facility where any spectators will have a close viewing opportunity.
- Competitors need to change in and out of boats frequently, so the course should be near a dock or pontoon. If a course cannot be arranged so that there are close changing arrangements on land, then consider arranging for a floating change platform, or providing a rib to transport changing teams to and from the race area. If doing on the water changing, consider positioning the change boat near the

finish to maximise the time swapping-in competitors have for familiarising themselves with the boat.

- Competitors will need access to facilities and refreshments during the racing. If racing cannot be in close proximity to the club house then alternative arrangements will be required.
- While only a small area is needed for a course, the area does need to be large enough to be able to set the course in any wind direction.
- There should be minimal tide or current across the course.

U.8 Start of the Regatta

There are two additional elements to consider at the start of a team racing event.

U.8.1 Competitor registration including damage deposit

Registration will usually include damage deposit where using borrowed boats. Some damage should be anticipated given the large numbers of close races in varying conditions. Charging for damage not only covers the cost of damage, essential for borrowed boats, but as importantly provides an incentive for teams to minimise damage. Generally this works well and very little if any money needs to be charged.

A Damage Officer is appointed to oversee the assessment of damage and allocation of costs to teams (see Section 2.6).

U.8.2 Umpire meetings

Given the importance of rule interpretations and the active role umpires play throughout an event, umpire meetings have more significance than in a fleet race.

An umpire team will generally want to have a meeting beforehand to review and ensure they are all aligned on the procedures they will use during the event, any rule interpretations, etc.

Significant interaction between the umpires and competitors is also likely. Competitors will frequently wish to raise questions or seek clarification on the interpretation of rules, and umpires will normally wish to provide the opportunity to do this both in writing and at briefing meetings.

Briefings should be interactive. The use of magnetic boats on a magnetic white board to demonstrate moves is recommended to make the briefings to make it easier to demonstrate specific rules or replay incidents.

U.9 Setting the Course

U.9.1 Course geometry

'S' course

The 'S' course is the most frequently used for team racing as it allows 2 or 3 races to be taking place simultaneously. The diagram below shows a starboard hand 'S' course.

There may be more than one race on the course

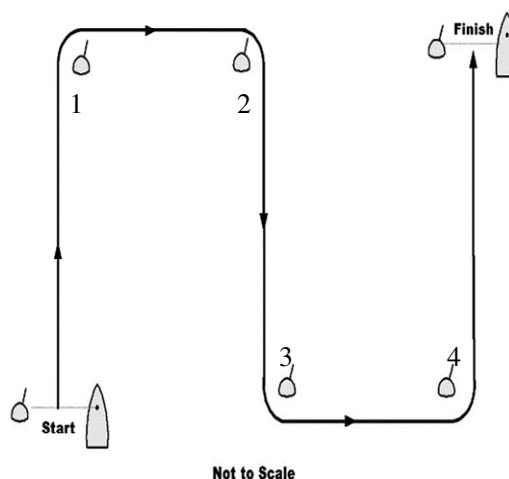

at any one time, so where possible the course should be laid so as to minimise the possibility of interference between races. For example, when laying an “S” course, care needs to be taken when positioning mark 3. If it is likely to be near the start boat it is better to have it upwind so as to minimise interference from other boats starting.

A starboard hand S is normally used as this provides the opportunity for interesting tactics at the first starboard mark.

A port hand ‘S’ is the mirror image with the marks left port-port-starboard-starboard- finish, but with start and finish boats at the starboard end of their respective lines. This may be appropriate if a starboard hand S is not suitable, and has the advantage that starboard rounding of marks 3 and 4 offers more interesting opportunities for place changing towards the end of the race and requires significant changes in tactics and rule awareness.

Other course options

If the finish line does not need to be separate, a starboard box course has the advantage of providing interest across the whole race. If this course is used and there is only one committee boat, consider using different sides of the boat for start and finish lines.

A further variation is to combine the start of a square with the end of an S. This is akin to a ‘W’. Whilst it can be more complex to manage, it provides opportunity for place changing throughout the entire race, which makes it very attractive for team racing.

An ‘L’ course can also be used (see on the right).

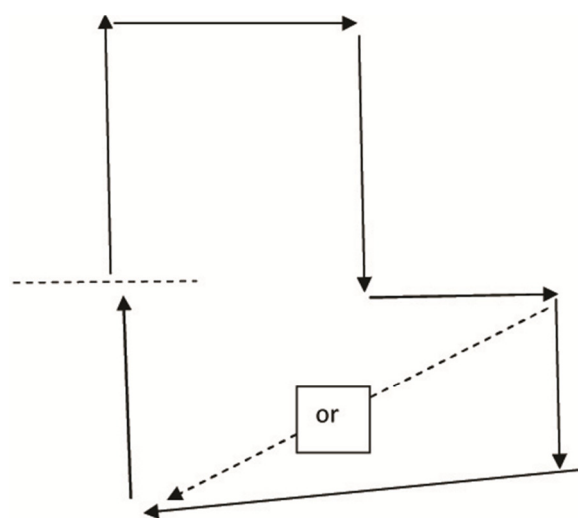

U.9.2 Location of Race Area

The general principles for selection of the race area are covered in Section 6.2.

At most locations, there will be a designated area for the racing. Once racing has started, the intention will be to keep going all day with continuous small adjustments, so the initial course should be set with space around to allow for the flexibility to move marks should wind shifts occur.

The specific location constraints may also influence whether port or starboard hand courses are necessary.

U.9.3 Length of starting line

The line should be relatively short, about six boat lengths long. However, when racing is for less experienced sailors a longer line may be preferable.

U.9.4 Course

The most significant difference to fleet racing is average length of race: this will depend on the boats and conditions, but in most cases ideally races will take around 7 to 8 minutes to complete. Less than 6 or more than 9 and the course should be adjusted. The first beat should ideally take around 2 minutes.

Whilst all the legs should be as true as possible, this is particularly important for the beats.

One consideration when setting up the course initially is the expected movement of wind during the day.

- When using a starboard hand course, if the wind changes anti-clockwise, it is easy to adjust the course (reaches get longer).
- Conversely if the wind moves clockwise, then the course tightens quickly and it may be necessary to move the start or finish.
- Significant disruption to racing can be avoided if the course is laid with capacity to adjust to expected wind changes.

U.9.5 Adjusting a course for wind changes

The need to keep the course close to ideal, in both length of race and setting in relation to the wind, coupled with the large number of races, makes rapid and frequent movement of marks essential for smooth running of a team racing event. The course is also very small so marks are easily visible. Mark movement is therefore more informal than in fleet racing.

Adjustment procedure

In team racing, marks can be moved at any time provided there are no boats heading immediately towards the buoy, so racing does not have to be stopped. The course setter usually moves in quickly, drags the mark to the new position and gets out of the way. There is no requirement to show any flags or make any sound signals (which must be reflected in a Sailing Instruction stating that RRS 33 does not apply).

If larger adjustments are needed, the course setter can request a break in racing.

When conditions are especially shifty the course setter may lay a number of optional windward marks and indicate just before the start which mark is to be used (eg by the course setter placing a flag on the best positioned mark just before the start of the race, or the start boat can display a signal if marks are different colours).

U.10 Starting Procedures

Use a compressed start sequence to minimise any lost time between races. In most events the start sequence will be signals at 3, 2 and 1 minutes.

Many race officers use a 'rolling watch', which keeps running throughout the day, with any signal being made at the start of any full minute (ie '00').. This is welcomed by competitors as they never have to re-set their watches during the day.

Electronic countdown systems are also used. These are totally audio signaling systems, largely removing the need for sailors to have watches. Typically there will be audio signals at 3, 2 and 1 minutes, then 30 seconds, 20, 10, 5,4,3,2,1, Go. Timing is taken from first sound. Flags would only be used for indicating which flights are sailing.

As races are very short, the OCS procedure needs to be very prompt and clearly audible. A good practice is to start by calling the number of boats over the line, and then the specific boat numbers. Some form of amplification (a loud hailer or speaker system) is recommended to ensure calls can be heard at the far end of the line.

General recalls should be avoided – it is preferable to call all boats over.

Team racing works best when starts are evenly spaced and continuous throughout the day. This spreads the races out as far as possible and maximises the use of umpires (thus minimising the number required). So for example, if the target is 12 races per hour, the start boat should be aiming for a start every 5 minutes.

If starts are being scheduled 3 minutes apart, the start signal for one race should be the 3 minute signal for the next race.

The start boat should display the race number of the race about to start, normally through writing on a board or using a set of numbers.

U.10.1 Starting problems and solutions

Starting line

As there are relatively few boats, and the line is short (see Section 8.4) a completely fair line is generally less critical for team racing than fleet racing. However, severely port biased lines have the effect of shortening the line, so should be avoided.

Boats should not be able to lay the first mark from either end of the start line. Given the short beat, it is important to watch for shifts that could have this result, and if necessary the race officer should abort the start.

Delays

It is important for the efficient running of the event that racing does not wait for teams who are late through their own action. If this is established early in the event then teams will be punctual rather than miss races, and so delays in racing avoided.

There is no need to wait for the course to be fully set before commencing the start sequence. This includes the starting mark which can be moved up to the 1 minute signal.

At most events one of the main controlling factors in the ability to start races will be the availability of the umpires. Provided the umpires are in place or on their way by the 2 minute preparatory signal that is all that is required.

It is important to establish a good working relationship between the start boat and the umpires, to avoid each waiting for the other. The start boat should expect to be ‘pulling’ umpires away from their previous race as it finishes, if the 3 minute signal is made it gives them up to 2 minutes to get back to the start.

Occasionally the umpires will need to switch boats, or will need to take some time to talk to the competitors about a call made during the race (although this should normally be done on shore after racing to avoid delay). If necessary, they should radio through to the PRO and ask for a slight delay in racing.

U.11 During the Race

U.11.1 Fleet surveillance

Fleet surveillance during racing is not a significant requirement for the race management team in team racing as:

- Races are much shorter so there is less opportunity for issues to emerge;
- The course setter should make small mark adjustments without reference;
- Umpires with fleets tend to raise awareness of any problems.

Abandoning a race

Any decisions on abandoning a race should be made by the Race Officer. They should normally be made in consultation with the umpires on that race, who will have a perspective on fairness and very local wind conditions. This will assist in making an informed judgment:

- If a race has been satisfactory up to the point where the wind dies, and teams have earned their positions, and those positions are likely to be maintained to the finish, it is normally fairer to continue racing;
- If however the positions of the teams has been impacted by the poor conditions it may be more appropriate to abandon the race in progress.

Given the above points, it is not uncommon in team racing to abandon some rather than all races actively underway. The normal process of abandoning a race would not be appropriate in these circumstances as there is no standard signalling to identify individual races once underway. It is therefore usual in team racing to communicate abandonment to the competitors in the race(s) impacted orally through the umpires (coordinated by the Chief Umpire, on request from the Race Committee).

U.11.2 Course changes

As described in section 8, team racing ideally has an effective course setter who constantly makes small adjustments, so it should only be necessary to pause racing to re-set the course if there is a major wind shift.

If this happens, it is useful to ensure the umpires are advised so they are aware what is happening, as well as taking advantage of the opportunity for a short break.

Management of target length course

As discussed in Section 8.6 the course setter will normally work to an average target length of course of 7 to 8 minutes. The race scheduler should actively monitor progress through the intended schedule during racing and advise the PRO if it seems appropriate to adjust the target length for a period to ensure timely completion of a phase of the race programme. The PRO can then make a decision regarding course length adjustments taking account of what is happening on the water.

For instance, it may become apparent with 4 hours of sailing left that in order to complete a round of the competition the pace of racing needs to increase. Reducing the course length from 8 minutes to closer to 6 minutes would enable an extra race per flight per hour, so eg if there are 3 flights this would result in completion of an extra 12 races. (Note the time between starts would also need to be adjusted).

U.12 Finishing

Whilst this is largely similar to fleet racing, there are two particular challenges to be expected.

- Racing is typically very close over a short course. Finishes can therefore be extremely close, with several boats crossing the line at almost the same time. As boats can be travelling at quite different speeds (team racing tactics see boats sailing as slow as possible at times), good line judgement is essential.
- There are often incidents at the finish, that result in boats finishing then crossing back to take a penalty turn and then re-finish. The standard procedure is to write down the number each time a boat crosses the finish line then confirm the actual finish positions with umpires.

The colour and number of each finishing boat should be recorded, and as above the order in which boats cross the line should be written down and any multiple crossings checked with umpires to confirm the place to be awarded.

U.13 Things to do at the End of Each Racing Day

It is usual for a competitor de-brief to be held. Whilst the focus of this is frequently the on the water decisions by umpires and rule interpretations, it is good practice for representatives of the race management team to attend to brief teams on plans for the next day's racing and answer any questions teams may wish to raise.

The race programme for the next day should also be announced, in particular which teams will be race first as they will normally need to rig and launch the boats in the morning.

U.14 Things to do at the End of the Regatta

The only specific consideration for team racing is the loading up of boats and sails if provided by the Organising Authority. This is a major undertaking for a large event, and it should be made clear in the Sailing Instructions that competitors must assist in loading to ensure that most is completed prior to the prize giving.

U.15 Post Regatta Tasks

The only significant difference for team racing compared to fleet racing after the event is where boats have been provided by the Organising Authority.

After several days of heavy racing, boats will need to be inspected for damage and any necessary repairs or maintenance undertaken. Depending on the source of the boats used, arrangements may also need to be made for them to be returned.

Following boat assessment, damage costs can be finalised and collected from damage deposits, and any balance returned to competitors.

U.16 Annex 2.6

EXAMPLE OF DINGHY TEAM RACING RE-SAIL GUIDELINES

These are not rules or sailing instructions. They are only guidelines and individual cases may have extenuating circumstances requiring a different interpretation. Also there may be differences at individual events; the briefing events for each event should note changes.

Re-sails will generally NOT be granted in the following circumstances:

- Failure to display a red flag when becoming aware of the facts in of the breakdown;
- Failure to apply for a re-sail within protest time;
- Knots becoming untied below half-way up the mast;
- Equipment such as shackles becoming loose or undone below half-way up the mast;
- Less than approximately 5 litres of water in a buoyancy tank;
- Where boats have not tried to continue racing;
- Where the breakdown was the fault of the crew;
- Where a reasonably competent crew would have been able to avoid the breakdown;
- A breakdown caused by careless handling, capsizing or a breach by a boat in the same team;
- Rudders lifting through lack of securing down devices, pins or rope;
- Tiller extensions parting from tiller, unless the fitting is faulty and there has been an unsuccessful attempt by the crew to re-assemble it.

Re-sails generally WILL be granted in the following circumstances:

- Knots becoming untied above half-way up the mast if not the fault of the crew;
- Equipment such as shackles becoming loose or undone above half-way the mast if not the fault of the crew;
- Broken toe straps in hiking out conditions but NOT those coming undone;
- More than approximately 5 litres of water in a buoyancy tank;
- Breakdowns caused by a breach of rule by an opponent;
- Wear and tear (such as a wooden rubbing strake becoming loose) which results in the boat becoming dangerous to either its occupants or other sailors.

U.17 Annex 6.1

Developing An Event Format

The objectives of a team racing event are:

- To provide competitive sailing to all the competitors for as long as possible;
- To produce a winner;
- To produce a rank order.

As described in the Section 6.1, team racing competitions normally start with Round Robin racing to maximise the amount of sailing. Many then finish with a knock out stage competition to select the final winner.

As most competitions use this approach, the remainder of this annex sets out the considerations used when developing this type of format.

Other Format Options

There are other possible formats for team racing competitions. Two of the most common are summarised below.

Swiss league

The *Swiss League* system is similar to a squash ladder, where two winning teams from one round sail against each other in the next round, with similarly two losing teams from that round sailing against each other. Running this type of competition successfully requires significant levels of experience and sophisticated computing, as results and schedules for the next round need to be calculated in real time.

A Swiss league competition can provide excellent racing between teams of comparable performance, and is an excellent tool for seeding. However it is generally too complex for most events.

Random pairs

Whilst normally competitions are team based, it is also possible to do team racing where competitors enter individually, but are then paired with different team mates at random during the event. Each member of the winning team will score a race win, competitors are then mixed up so that the next round teams are different pairings. Again, each team member scores the same points as the team. At the end of the competition, the winner is the competitor with most race wins – in other words, they have been in more winning teams than any other competitor.

This basis of competition is particularly useful for classes or clubs, or where sailing standards are mixed, where the objective is to get sailors meeting each other and having some fun racing.

Developing an event format

How many races?

The starting point for developing a format is to assess the maximum number of races that are anticipated during the event.

If a race is c 8 minutes and change over between teams is quick, it is reasonable to assume 4 races an hour for each flight (ie set of boats for a single race). This is the equivalent of each fleet being able to complete a whole cycle of pre-start – race – change over – back ready to pre-start in 15 minutes.

The maximum number of races is then the total number of flights (sets of boats) multiplied by 4 multiplied by the anticipated hours of racing. This should be used as the basis for setting the overall plan for the competition.

Example:

Assume a 16 team event, with 4 sets of boats (the ‘ideal’ ratio so competitors can sail half the time).

- Racing from 10 am until 6 pm, over 3 days.
- Last half day reserved for semi finals and finals.
- Races per hour = 4 (flights) x 4 (races per flight) = 16
- Maximum Round Robin races = (8 + 8 + 3) hours of racing x 16 = 304 races

So the ‘ideal’ format of Round Robin racing would have around 300 races in it.

It is highly unlikely that racing can run at this maximum rate over all days, as there is inevitable down time for gear failure, wind changes etc. It is therefore important to develop contingencies in the format, so that there is clear plan for any eventuality.

So in this example, the format should include:

- 1 A maximum race plan for around 300 races;
- 2 'What if' race plans that allow for losing time at various stages during the overall event.

Which Round Robins?

The number of races for a Round Robin of n teams can be calculated using the formula:
 $n * (n-1) / 2$.

The aim for a set of Round Robins is to offer teams the same number of races. So Round Robins are usually chosen that divide the fleet evenly, for instance:

- For a 16 team event, one Round Robin of 16 teams, or 2 Round Robins of 8 teams;
- For a 15 team event, one Round Robin of 15 teams, or 1 Round Robin of 7 and 1 Round Robin of 8 teams, or 3 Round Robins of 5.

The choice of Round Robin format is then a balance between various factors including:

- Fair sailing eg providing every team with a chance of winning;
- Random allocation of teams vs moving to seeded groups to provide more peer based racing opportunities;
- Confidence in finishing the competition.

When is an 'all sail all' full Round Robin appropriate?

It is common to start an event with an 'all sail all' Round Robin. This provides an opportunity for all teams to race each other, establishes an overall first placed team at the start of the competition (so there is a winner should no further rounds be completed), and establishes a seeding order that can be used to divide teams in future rounds.

The downside of an 'all sail all' Round Robin for large events is that they take a lot of race time, and if the standard of team racing is very variable between teams the racing may be disappointing.

If planning an 'all sail all' Round Robin, it is therefore advisable to start by dividing teams into two roughly even groups and sailing them as two mini-Round Robins as one phase, before sailing the remaining races in the major Round Robin as a second phase. This approach provides a contingency option of dropping the completion of the major Round Robin if event conditions are not favourable.

Other Round Robin options:

The first Round Robin round of a competition generally has teams of mixed standard, either on an 'all sail all' Round Robin, or by pre-seeding teams into roughly even groups. The results of this first round then establish a seeding for the particular event.

Subsequent rounds usually split teams into two or more Round Robins based on sailing performance in the event to date (eg a gold Round Robin for the top teams, and a silver Round Robin for the lower performing teams).

Multiple rounds may be sailed. If this happens, there are a number of options to consider:

- Results may be carried forward between rounds providing that the same teams remain;
- If results carry forward, it is possible to award more points for a race win in later rounds (eg 1 point for a race win in round 1, 1.5 points for a race win in round 2, etc).

Another option is to consider promoting the top team(s) from lower Round Robins and relegating the bottom team(s) from top Round Robins.

If the end of the event will move into a knock out competition (semis / finals, possibly quarter finals), then consider either the top placed silver team having one of the quarter final places, or sailing a repechage where the top of silver sails against the middle placed gold teams to decide who goes into the semi / quarter finals. This opportunity for the first placed in silver to reach the finals maximises the number of teams with the potential to win in the later stages of the competition, and keeps the competition alive for them.

When considering options, there is a need to balance:

- Providing teams with credit for good performance early in the competition;
- Ensuring the sailing remains interesting with the potential for as many teams as possible to have a chance of winning as late as possible in the competition.

Example: 16 team, 3 day format

Going back to the example above, this was a competition for 16 teams over 3 days, with a maximum of around 300 races for the Round Robin stage.

An 'all sail all' 16 team Round Robin would take 120 races;

- Two Round Robins of 8 teams would take 56 races;
- Four Round Robins of 4 teams would take 24 races.

A possible format would be:

- Start with an 'all sail all' 16 team Round Robin (120 races). This should be sailed starting with two approximately balanced 8 team Round Robins (56 races), then completing the rest of the races (a further 64 races);
- Move to 3 rounds of gold / silver 8 team Round Robins, with 2 teams promoted from silver / relegated from gold at the end of each round (168 races);

The total is a maximum of 288 races.

Contingencies would be:

- Replace the third round of gold / silver with 4 x 4 Round Robins;
- Replace the third round of gold /silver with gold (5 teams), silver (6 teams) and bronze (5 teams);
- Do not sail the last round of gold / silver;
- Sail only one round of gold / silver;
- Curtail the 'all sail all' 16 team Round Robin after completing the two 8 team mini Round Robins, and move straight to a gold / silver Round Robin round.

U.18 Annex 6.1.1

EXAMPLE SCHEDULE

Below is an example schedule, used in the World Team Racing Championship in 2007.

Note that only one team changes after most races.

Flight 1		Race Number	Flight 2		Race Number	Flight 3	
Yellow 1, 2, 3	Blue 4, 5, 6		Green 7, 8, 9	Red 10, 11, 12		Black 13, 14, 15	White 16, 17, 18
AUS 1 v	ESP 3	1			1		
		2	IRL1 v	AUS 3	2		
		3			3	USA 2 v	IRL2
AUS 1 v	GBR 2	4			4		
		5	IRL1 v	ITA 1	5		
		6			6	USA 2 v	NZL 1
ESP 2 v	GBR 2	7			7		
		8	GBR 3 v	ITA 1	8		
		9			9	IRL3 v	NZL 1
ESP 2 v	USA 1	10			10		
		11	GBR 3 v	ESP 3	11		
		12			12	IRL3 v	JPN 1
IRL1 v	USA 1	13			13		
		14	AUS 3 v	ESP 3	14		
		15			15	AUS 2 v	JPN 1
IRL1 v	AUS 1	16			16		
		17	AUS 3 v	ITA 1	17		
		18			18	AUS 2 v	ESP 1
GBR 3 v	AUS 1	19			19		
		20	GBR 2 v	ITA 1	20		
		21	Both Teams Change		21	GBR 1 v	ESP 1
GBR 3 v	ESP 2	22			22	Both Teams Change	
		23	JPN 1 v	NZL 1	23		
		24			24	USA 2 v	AUS 2
ESP 3 v	ESP 2	25			25		
		26	JPN 1 v	IRL2	26		
		27			27	USA 2 v	IRL3
ESP 3 v	USA 1	28			28		
		29	GBR 1 v	IRL2	29		
		30			30	ESP 1 v	IRL3
AUS 3 v	USA 1	31			31		
		32	GBR 1 v	NZL 1	32		
		33			33	ESP 1 v	USA 2
AUS 3 v	GBR 2	34			34		
		35	AUS 2 v	NZL 1	35		
		36			36	JPN 1 v	USA 2



ISAF RACE MANAGEMENT MANUAL

SECTION V

Safety Management

Contents	Page
V SAFETY MANAGEMENT	
V 1 Objectives	V 2
V 2 Introduction	V 2
V 3 Risk Assessment And Crisis Management Plan	V 2
V 3.1 Risk Assessment	V 2
V 3.2 Crisis Management Plan	V 2
V 4 Influence Of Event Types On Safety Provision	V 3
V 5 Responsibilities	V 3
V 5.1 Competitors	V 3
V 5.2 Race Officer	V 3
V 6 Outline Structure Of Safety Plan	V 4
V 6.1 Dinghy and board events	V 4
V 6.2 Ocean, offshore and yacht racing events	V 7

V.1 Objectives

The Objective of any safety policy to be adopted at an event is to provide efficient, competent safety cover thereby allowing competitors, officials and all those involved maximum enjoyment whilst minimizing the risks to their wellbeing, having regard for both expected and unforeseen conditions.

V.2 Introduction

RRS Rule 1, RRS Rule 4 and standard safety sailing Instructions confirm that a boat accepts that it is entirely responsible for its own safety. Nevertheless, safety is an area that should be actively managed, according to 'good practice', by race officers at any event at which they are involved.

The management of safety at any one event will be governed by differing procedures dependent on many factors. These factors include the types of boats involved, the numbers of boats and competitors, the course configuration sailed, the location of the race area, the sea hazards and the conditions that competitors may experience. However, events of all types have a common initial approach to safety management - a Risk Assessment and a Crisis Management Plan. It is common practice to have the risk assessment and the crisis management plan within the same document prefixed by general information on the event and the senior officials involved.

This section outlines the various issues that concern the management of the safety resources at any specific event in order to reduce the inherent risks associated with sailboat racing to a level as low as reasonably practical (ALARP). Race officers will need to address those issues applicable to their own event and adopt policies appropriate to their specific requirements.

V.3 Risk Assessment And Crisis Management Plan

V.3.1 Risk Assessment

A risk assessment must be carried out for every event so that potential risks can be identified and measures taken to minimize the risk to an acceptable level.

Each risk factor is identified and described together with its possible location. The probable consequences of the risk materializing are highlighted as are the control measures that are to be put in place in order to minimize that risk. An attempt to quantify or measure the risk, having implemented the control measures, is then made. It is likely that specific control measures will be appropriate to more than one risk factor.

The process of producing a Risk Assessment may reveal deficiencies in the anticipated safety management policy initially adopted and allows the race officer to implement further control measures to minimize the risk further.

V.3.2 Crisis Management Plan

Again, this is a document that must be produced well before the event is to take place. It defines the actions to be taken when a serious risk (as should have been identified in the Risk Assessment) is realized. The person(s) responsible for carrying out or supervising the appropriate action is identified by name or position and relevant contact details are listed. Potential sources of outside help are also defined with contact details (eg rescue or

emergency services, hospitals, etc). Dissemination of information after such an incident must also be managed so those responsible for this aspect should be identified.

V.4 Influence Of Event Types On Safety Provision

The safety management adopted differs according to the nature of the event. Factors influencing the type and amount of safety cover provided include:

- Boat types - the requirements of keelboats, dinghies, boards and model boats are very different from those of each other. Mixed fleets often pose complex problems of safety.
- Number of boats - both the type and the amount of safety cover is often determined by the number of boats and/or competitors.
- Location of racing - the safety requirements of ocean racing differ from offshore racing, racing inland or in an estuary.
- Ability of the competitors - it is often the ability of the less able sailors in the fleet that determines the level and type of safety cover necessary.
- Age of competitors - both the young and old have greater requirements when compared to fit adults.

V.5 Responsibilities

V.5.1 Competitors

RRS 1 clearly defines the responsibility of the competitor to wear a personal floatation device, whilst that rule, in addition to RRS 4, makes it clear that it is the boat's responsibility to make the decision whether or not to race (or continue to race having started) and to carry adequate life-saving equipment for those on board. It is also mandatory for competitors to assist any person or vessel, whether racing or not, that is seen to be in danger.

Sailing Instructions will require competitors to conform to a safety system that ensures that the race committee receives confirmation that a boat either intends to race and will be on the race course or that they are safe and no longer racing.

V.5.2 Race Officer

Unless local regulations require a PFD to be worn at all times whilst afloat, the decision to make the wearing of personal floatation devices whilst racing compulsory is that of the race officer as defined in RRS 40. There is therefore an implied duty of care in race management. In addition, the ISAF Code of Behavior requires all race management personnel to be responsible for their actions concerning the safety and welfare of race participants. So whilst there may be an extensive team involved in 'safety' at an event, the responsibility for this is ultimately that of the race officer in charge even when first line management is delegated to another individual(s).

The race officer must, at all times, monitor the fleet and observe the conditions in which they are racing. Priority is always the safety of the sailors whilst their boats are of secondary importance. The timing of any intervention is also important: a capsize is a normal part of some types of racing and an extreme situation in others; if the race can continue in safety without intervention then it should be allowed to do so. Rescue facilities must remain in force until all boats, racing or retired, are safely back ashore or in a safe haven such as a harbor or marina.

Medical facilities must be available either through the event itself with a doctor onsite, or through the emergency services and local hospitals. All boats involved in the management of an event should be equipped with a first aid kit as a minimum requirement.

V.6 Outline Structure Of Safety Plan

V.6.1 Dinghy and board events

Having completed the risk assessment the design of an appropriate safety plan is made. This is influenced by several factors.

V.6.1.1 The size and location of the race area

Racing in coastal waters and estuaries is often monitored by VHF on the main committee boat itself. Inland races can be monitored perhaps from the club office with visual contact through a window. A means of communication with the safety fleet will still be required.

V.6.1.2 Number of race areas

The requirement for a centralized system of communication and coordination of cover is determined by the number of race areas. At a major event with multiple course areas the most efficient management of the safety systems will be effected through a centralized base. Again, this could be afloat, as in the case of an event safety leader on a boat, or ashore in an office. Communication from the safety fleets to the central base is usually via VHF radio but may also be made with mobile telephones.

When racing is on a single course it is often not necessary to have a base other than the race officer in charge or a person delegated to manage the safety resources.

V.6.1.3 Mode of assistance

Dinghies and boats that are likely to capsize are best assisted by RIBs or similar small boats. It is common place to have a fleet that is positioned at predetermined points on the race course. A floating base such as a mother ship is a useful facility to which boats that cannot cope with the conditions are tied and made safe whilst others are rescued. A patrol plan for the RIBs is essential to effect good safety monitoring and cover. This plan must be defined and understood by all safety crews to patrol effectively when boats sail out to the race area, race and return to the dinghy park. Each safety boat will have designated area to patrol during the race and during transit of boats to and from the racing area. During the races safety boats will move to a pre-allotted patrol zone (see diagrams). Generally 1 or 2 boats would cover each leg of the course with overlapping areas around the marks. Boats should also be stationed at gybe marks as these are often problem areas. In the event of bad visibility, heavy sea, strong wind, etc, boats should also be stationed at the leeward aspect of the course to 'mop up' - this is especially important if the wind is offshore. If more safety boats are available some can have a roving role.

Windward Leeward Course

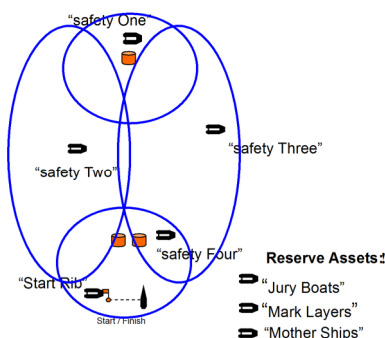

Trapezoid Course

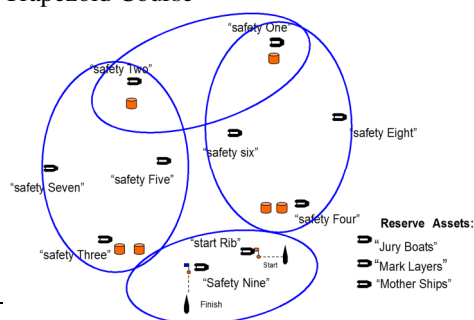

Sausage Triangle Course

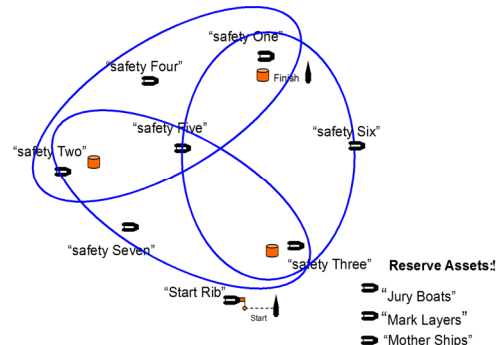

V.6.1.4 Intention to Race and Declarations

This is a requirement of the sailing instructions that enables the race officer to know who is on the water and who is on land or in harbor. In the case of dinghies and boards a tally or 'sign in / sign out' system allows the race committee to know who is on the water and who is on land.

V.6.1.5 Personnel

One individual will be assigned to the role of Safety Leader to coordinate all activity under the guidance of the race officer. There should be enough personnel in the team to provide a safety fleet appropriate to the course area, number of boats, age and ability of crews and the expected conditions. All Safety Boats should normally have a minimum of two competent adults aboard, one of whom should be dressed to enter the water to aid a rescue. There is no maximum number of crew but Safety Boats should not be overloaded with crew and should be able to accommodate additional sailors. It is unusual for a Safety Boat to have more than three crew members.

Other available personnel at the event should be available to help with safety issues when directed by the race officer - Jury / Umpire / Measurer / Coaches. This is not only limited to adverse conditions. Towing boats back to harbor could also be required.

V.6.1.6 Equipment

VHF radios and mobile telephones are necessary for dinghy racing.

Safety boats for dinghy events also carry:

1. Adequate fuel.
2. A sound generator (whistle or fog horn).
3. Compass
4. Anchor and warp suitable for the race area.
5. Sharp knife, preferably serrated and easily accessible.
6. Kill cord and spare, which must be used by the driver at all times when underway.
7. Personal buoyancy for the crew, to be worn at all times.
8. Safety Tape to identify abandoned boats (to be issued by the ESO).
9. Paddles and bailer.
10. Drinking Water.
11. Tow rope (preferably made of floating line) and towing bridle.
12. Waterproof first aid kit and survival bag or thermal protective aid.
13. Distress Flares – 2 orange smoke and 2 pinpoint red or 2 day/night flares

In addition it may be desirable to carry:

1. Wire Cutters, to cut away rigging and trapeze wires
2. Tool kit
3. GPS location equipment
4. Torch
5. Spare radios

V.6.1.7 Communication

Good communication is essential between all involved in any safety plan and, of course, the competitors themselves. Good briefings should be made by the race officer to the competitors before racing takes place and to the safety personnel usually on a daily basis.

Where VHF radios are to be used it is important that all users are able to communicate effectively when the conditions are poor, which is when the activity of the safety team may be at its greatest. Wind noise is the curse of good communication by VHF so it is important that users are familiar with good technique. Call signs should be listed, VHF channels assigned and adhered to, with reserve channels should a carrier exist or when other users outside of the event also need significant 'airtime'. A procedure for radio checks is necessary.

V.6.1.8 Emergency Guidelines

In the event of an emergency occurring (including severe injury to a sailor or event personnel or structural damage endangering the safety of a boat in the event), the first boat on the scene at a dinghy event, should inform all stations using a predetermined code (such as 'Code Red') and the location of the incident. The code itself is to be defined in the safety plan and emphasized at the briefings. An immediate assessment of the situation by the race officer is made and if appropriate the incident plan then becomes active.

If the situation is considered to be hazardous to the rest of the fleet the race officer may elect to stop racing by either shortening course or executing an abandonment as appropriate.

An emergency is only declared closed when the situation has been resolved. The race officer will only then inform all stations that 'CODE RED' is cleared.

V.6.1.9 Other Issues

The following issues need to be considered as core to safety management:

- a system with which to identify boats with crews removed such as marking with streamers.
- contingency plans for a change in conditions including the onset of fog.
- a liaison with shore-side facilities and emergency services to cope with medical emergencies and injuries including a designated point for landing such incidents.
- a policy for identifying and assisting crew at a capsized and when to intervene.
- knowledge of the boats racing and how to right a capsized boat of this type (often best obtained from coaches of the class concerned).

V.6.1.10 Safety Briefings

It is important that the safety team is briefed before the event commences and also on a daily basis. The latter is to ensure that the safety personnel work as a team and refine techniques as the event progresses. Whilst the RO is responsible for safety it is common practice for the safety officer to lead these briefings, but always with the RO present. At the initial briefing the following issues need to be addressed:

- introductions of the RO and other key people.
- any local hazards.
- the ability of the competitors racing.
- the tally system in place.

- the system used to identify boats that have had their crews removed such as marking the dinghy or board with streamers.
- the location of the mothership if one is available.
- the contingency plans for a change in conditions including the onset of fog and the use of GPS.
- the methods for dealing with injuries and medical emergencies.
- the location for landing injuries and medical emergencies.
- the method to be used to patrol effectively whilst sailing out to the race area, during the race and whilst returning to shore.
- the policy for dealing with capsizes and when to intervene.
- the correct method of righting a capsized boat of the type this safety team is responsible for (and those on other course areas if appropriate).
- the VHF channel to be used and backup channels should the main one become blocked.
- the correct method for using a VHF particularly when conditions are poor with strong winds.
- the definition of when and what to transmit on the VHF particularly if there is only one channel for the course area concerned - no chatter particularly during the start sequence.
- the policy for standing down at the end of the day.
- the times of daily briefings and debriefings.
- the collection and distribution of refreshments to take out on the water.

V.6.2 Ocean, offshore and yacht racing events

The basic concepts of safety remain the same as with dinghies and boards but there are other issues to take into account.

V.6.2.1 The size and location of the race area

Course areas are extended and may be out of sight of land. Offshore racing requires a 'base' that is responsible for monitoring the location and progress of those boats involved using all technology available - tracking devices and satellite communication systems when boats are likely to be far apart; VHF monitoring both by the competitors themselves and/or a 'base' when racing is likely to be relatively compact. The base will be either afloat, as in the case of a mothership, or on land. Whatever system is used it must have the ability to communicate with both the competitors and land based rescue services. Clearly this type of monitoring must exist at all times whilst racing is taking place so is likely to be a 24 hour watch from the start and until all boats have reached a harbor or other safe haven.

V.6.2.2 Mode of assistance

The delivery of assistance to competitors is determined by the types of boats racing. Large yachts are self-sufficient to a certain extent until they require the services of specialist rescue services such as is offered by coastguard agencies. In the case of injury to competitors on such yachts, they are often safer and more comfortable remaining on the yacht than being transferred to another vessel or RIB. Urgent attention is best effected by helicopter transfer.

V.6.2.3 Intention to Race and Declarations

This is a requirement of the sailing instructions that enables the race officer to know who is on the water and who is on land or in harbor. Again, it is dependent on the type of boat involved.

Yachts - common policy is a requirement that boats sail close to the main committee boat in the pre-start period and call the race committee by VHF when retiring from a race or returning to harbor prematurely. Prompt submission of paper declarations after racing is a common alternative.

V.6.2.4 Personnel

Fewer personnel are involved in safety for yacht and ocean racing. The skills of those involved are different, the main ability being communication and organisation - to alert the rescue services as is appropriate and coordinate activity where necessary whilst maintaining contact with the competitor and keeping them informed as to progress being made.

V.6.2.5 Equipment

The equipment required for ocean racing is limited to tracking devices, satellite communication systems and VHF radios. VHF radios and mobile telephones are necessary for inshore yacht racing.

V.6.2.6 Communication

Good communication is essential between all involved in any safety plan and, of course, the competitors themselves. Good briefings should be made by the race officer to the competitors before racing takes place. This is sometimes in the form of 'competitors' notes' when boats are not located in the same place and arrive at the race area from many different locations.

V.6.2.7 Emergency Guidelines

In the event of an emergency occurring, the competing yacht should inform all stations using a predetermined code (such as 'Code Red') with incident details including its location.



ISAF RACE MANAGEMENT MANUAL

SECTION W

Kiteboarding

Contents

Page

W KITEBOARDING

W 1 Objectives

V 2

W.1 General

W.1.1 Race Committee

100 % same as for normal fleet racing. Experience with what kites can and cant do helps, especially in weather changes. Kites use different sail sizes – if there is a big change in wind strength (expected), AP over H is recommended to allow equipment change. Course setup and target times: windward/leeward with spreader mark and leeward gate, optional is a slalom finish like in windsurfing. For target times, we have good speed charts that we can give you.

The medal race series might be a bit different – with details to be discussed in November

W.1.2 Judges

W.2 Introduction

text

W.3 heading

W.3.1 heading

text.